

Operator's Handbook

AutroMaster ISEMS - Integrated Safety and Emergency Management System



COPYRIGHT ©

This publication, or parts thereof, may not be reproduced in any form, by any method, for any purpose.

Autronica Fire and Security AS and its subsidiaries assume no responsibility for any errors that may appear in the publication, or for damages arising from the information in it. No information in this publication should be regarded as a warranty made by Autronica Fire and Security AS. The information in this publication may be updated without notice.

Product names mentioned in this publication may be trademarks. They are used only for identification.



Table of Contents

1. Introduction.....	1
1.1 About this handbook.....	1
1.2 The reader.....	1
1.3 Reference Documentation.....	1
2. AutoMaster ISEMS	2
2.1 Introduction.....	2
2.2 AutoMaster Editions	3
3. Startup.....	4
4. Graphical User Interfaces	5
4.1 Introduction.....	5
4.2 The Display.....	5
4.2.1 The Taskbar.....	5
4.2.2 Menus at the Top of the Screen.....	7
4.3 System Operating Techniques	10
4.3.1 The Graphical System.....	10
4.3.2 Moving a Window.....	11
4.3.3 Minimizing and Closing Windows.....	11
4.3.4 Resizing Windows.....	11
4.4 Overview – Loop Units/Point Menus	12
4.4.1 Overview – Description of Point Menus	13
4.4.2 Overview – Emergency Lighting.....	14
4.4.3 Overview – Description of Emergency Lighting Menu Items	14
5. Standard Graphical User Interface.....	15
5.1 The Presentation Window	15
5.2 Navigation Technique.....	16
5.3 Changing Between Mimics	17
5.3.1 Select Areas.....	18
5.4 Selecting a Detector or Point.....	19
5.4.1 Selecting Detectors	19
5.4.2 More Text for a Point.....	20
5.4.3 Point Menu	21
6. AutoBrowser.....	22
6.1 Introduction.....	22
6.2 The Presentation Window	23
6.3 Detail Pane	25
6.4 Static Navigation Pane	25
6.5 Dynamic Navigation Pane	26
6.6 Mimic Control Pane	26
6.7 Layer Control Pane.....	27
6.8 More Text Pane.....	27

6.9	Pane Control Pane	27
6.10	Status Bar (configurable).....	28
6.11	EPT Actors/Objects Pane.....	28
6.12	Default Utility Buttons	29
6.13	Configurable Buttons	30
	6.13.1 Shortkeys – Overview	31
6.14	Quick Mouse Operation.....	31
	6.14.1 Display a Mimic	31
	6.14.2 Scroll inside the Navigation Pane.....	31
	6.14.3 Scroll inside the Detail Pane	32
	6.14.4 Zoom In/Out the Detail Pane.....	32
	6.14.5 Brightness Adjustment	32
6.15	Customizing the Layout	33
	6.15.1 Rearrange Panes	33
	6.15.2 Resize Panes	34
	6.15.3 Hide or Make Panes Visible	34
	6.15.4 Save layout.....	34
6.16	Operating Techniques – Using Touchscreen Functionality.....	35
	6.16.1 Default Utility Buttons	35
	6.16.2 Mouse Mode Normal (navigation/select).....	35
	6.16.3 Mouse Mode Multiselect.....	35
	6.16.4 Mouse Mode Pan	35
	6.16.5 Mouse Mode Zoom	36
	6.16.6 Mouse Mode Brightness (Day/Night mode)	36
6.17	Selecting Mimics.....	36
6.18	Selecting Detectors	39
6.19	Accessing Point Menus	40

7. Alarm Situation41

7.1	In the Event of an Alarm.....	41
7.2	In the Event of Several Alarms.....	43

8. AutoMaster Menu44

8.1	Reset screen	45
8.2	Object list.....	46
	8.2.1 Functions in the Object List.....	46
8.3	Network topology BS-100.....	47
	8.3.1 Functions in Network topology	47
	8.3.2 Functions in the Information Window for Control Panels	49
8.4	Detector group manager	54
	8.4.1 Creating Groups.....	54
	8.4.2 Adding Detectors from the Graphic Display	55
	8.4.3 Adding Detectors from the Object list	56
	8.4.4 Deleting Groups	57
	8.4.5 Disabling a Group.....	58
	8.4.6 Enabling a Group	59
	8.4.7 Time Program for Enabling/Disabling	60
8.5	Object browser	62
	8.5.1 General.....	63
	8.5.2 Example	64
8.6	System history	66
8.7	Printouts	67
	8.7.1 Print Screen.....	67
	8.7.2 Print window	67
8.8	Maintenance	68

8.8.1	Show version.....	68
8.8.2	Select Language	69
8.8.3	Date/Time.....	70
8.8.4	Backup tools.....	70
8.8.5	Configuration	72
8.8.6	Command line	73
8.9	Help	73
8.10	Shut Down	73

9. Report Generator74

9.1	Introduction.....	74
9.2	Main Page	74
9.3	Common Functions	75
9.4	List Reports	75
9.5	Generate Reports	76
9.6	History	76
9.6.1	History Type	77
9.6.2	Saving the Report.....	79
9.7	Analogue Values	80
9.7.1	Analogue Values	80
9.7.2	Range.....	80
9.8	Disablements.....	81
9.8.1	Disablements	81
9.8.2	Select Group	81
9.8.3	Displaying Disablements	82
9.9	Configuration	82
9.9.1	Configurations	82
9.9.2	Select Mimic.....	82
9.10	Version Information	83
9.10.1	Software Version	83
9.10.2	Select Version	84
9.11	Miscellaneous.....	84

10. History86

10.1	Functions in the History Window	87
10.1.1	Scrolling in the History Window.....	87
10.1.2	Dating Events	87
10.1.3	Reading Analogue Values.....	88
10.2	The Vertical Menu	88
10.2.1	Zoom Vertically.....	88
10.2.2	Show All Possible Events.....	89
10.2.3	Show Changed and Active Events	89
10.2.4	Show Only Changed Events	90
10.2.5	Show Waveforms Only.....	90
10.2.6	Show Waveforms and Events.....	91
10.2.7	Do Not Show Waveforms.....	91
10.2.8	Want to See Alarms Only.....	92
10.2.9	Show Special Events.....	92
10.3	Horizontal	93
10.4	Miscellaneous.....	93
10.4.1	Show Timestamps.....	93
10.4.2	Sort Events	94
10.4.3	Quick Refresh	94
10.4.4	Variable Text Width.....	95
10.4.5	Waveform Scale: Visible Min/Max	96
10.4.6	Waveform Scale: Total Min/Max	96
10.4.7	Standard Waveform Scale	97

10.4.8 Squared-Off Curves	97
10.5 Other Buttons	98
10.5.1 The <==> Button	98
10.5.2 The =><= Button	99
10.5.3 The <==> Button.....	100
10.5.4 Report Time	100
10.5.5 Adding Detectors to the History Window.....	101
11. Disable/Enable Detectors.....	102
11.1 Working with Several Points.....	103
11.2 Disabled Points.....	104
11.3 Detector Group Functionality/Overlapping Groups.....	104
11.4 Replication.....	105
11.5 Future Actions	105
12. Information Layer	106
12.1 Activating/Deactivating an Information Layer Using Buttons.....	106
12.2 Activating/Deactivating an Information Layer from the Object List.....	107
13. Operating Emergency Lighting.....	108
13.1 Gessler and Dardo Emergency Lighting.....	108
13.2 Symbols.....	108
13.2.1 Gessler Emergency Light System	109
13.2.2 Dardo Emergency Light System.....	109
13.3 Commands.....	110
13.3.1 Gessler Emergency Light System	110
13.3.2 Dardo Emergency Light System.....	111
14. Watchdog	112
15. Time Synchronization.....	113
16. Fire Doors.....	114
17. Low-Location Lighting	115
18. Fire Patrol Supervisor	116
19. Closed-circuit Television (CCTV)	117
20. Video Module	118
21. Programmable Logic Controllers	120
22. Network Monitoring (SNMP)	121

23. AutoSafe and Autoprime	122
23.1.1 Detection Zones	122
23.1.2 Selecting Detectors	123
23.1.3 Alarm Mimic from the fire alarm system	123
23.2 History Functions	124
24. AutoSafe Dual Safety with AutoMaster as a Top-level System.....	126
24.1 AutoSafe Dual Safety Concept.....	126
24.2 Primary and Secondary System	126
24.3 Active and Standby Mode.....	126
24.4 Indications	127
24.5 Automatic Transfer of Loop Control	127
24.6 Give or Take Loop Control	128
25. Duty Control	129
25.1 Transfer Duty Control	129
25.2 Acquire Duty Control	130
26. Decision Support System.....	131
26.1 Operating AutoMaster DSS.....	131
26.1.1 Selecting an Incident.....	133
26.1.2 General Layout of the Incident Viewer	134
26.1.3 Log Entry View	136
26.1.4 Data Field View	136
26.1.5 Incident Close View.....	137
26.1.6 Reports.....	137
26.1.7 Operator Action Data Entry	138
27. Electronic Plotting Table.....	140
27.1 Introduction.....	140
27.2 Actors and Objects	141
27.2.1 Introduction.....	141
27.2.2 Symbols Displayed in the EPT Actors and Objects Pane	141
27.2.3 Actors	142
27.2.4 Objects	142
27.2.5 Symbol Information	143
27.2.6 Symbol State Indication.....	144
27.3 Accessing Symbol Menus	145
27.3.1 Inside the EPT Actors and Objects Pane.....	145
27.3.2 Inside the Detail Pane	145
27.4 Drag and Drop	146
27.5 Cleaning Symbols.....	146
27.6 Polygons	147
27.6.1 Overview	147
27.7 On Scene Commander Symbol.....	149
27.7.1 Overview	149
27.7.2 Menu Selections.....	149
27.8 Mobile Fire Group Symbol.....	150
27.8.1 Overview	150
27.8.2 Menu Selections.....	150
27.9 Stretcher Team Symbol.....	151
27.9.1 Overview	151
27.9.2 Menu Selections.....	151

27.10	Supply Team Symbol	152
27.10.1	Overview.....	152
27.10.2	Menu Selections	152
27.11	Staging Area Symbol.....	153
27.11.1	Overview.....	153
27.11.2	Menu Selections	153
27.12	Source Location Symbol.....	154
27.12.1	Overview.....	154
27.12.2	Menu Selections	154
27.13	Boundary Cooling Symbol	155
27.13.1	Overview.....	155
27.13.2	Menu Selections	155
27.14	Casualty Symbol.....	156
27.14.1	Menu Selections	156
27.15	History Window.....	157
28. Event Recording and Replay		158
28.1	Introduction.....	158
28.2	Automatic Start of Recordings.....	158
28.3	Manual Start and Stop of Recordings.....	158
28.4	General Layout	159
28.4.1	Toggling between Full Scale Picture and Zoom.....	159
28.4.2	Sequence Window	160
28.4.3	Information in Bottom Window	160
28.4.4	Function Buttons	161
28.4.5	Play Button	161
28.4.6	Export Button.....	163
28.4.7	Delete Button.....	164
29. Training/Simulate Module		165
29.1	Introduction.....	165
29.2	The Training/Simulate Window	166
29.3	Function Buttons.....	166
29.4	Starting the Training Module	167
29.5	Starting and Stopping a Scenario.....	167
29.6	Starting an Event from the Detail Pane	168
30. Message Center		169
30.1	Introduction.....	169
30.2	Using the Message Center	169

1. Introduction

1.1 About this handbook

This handbook provides information to successfully operate the AutoMaster Integrated Safety and Emergency Management System (AutoMaster ISEMS).

1.2 The reader

The handbook is intended for personnel who operate the AutoMaster Integrated Safety and Emergency Management System.

1.3 Reference Documentation

The AutoMaster ISEMS documentation consists of the following documents:

Document Name	Part number	File name
System Description	116-AMASTER-SYSTEM/XGB	amastersystem_xgb
Basic Configuration Handbook	116-AMASTER-BASICCONF/EGB	amasterbasicconf_egb
Advanced Configuration Handbook	116-AMASTER-ADVCONF/EGB	amasteradvconf_egb
Installation and Commissioning Handbook	116-AMASTER-INSTCOMM/IGB	amasterinstcomm_igb
Operator's Handbook	116-AMASTER-OPERATE/FGB	amasteroperate_fgb
Shortform User Guide	116-AMASTER-USERGUI/LGB	amasterusergui_lgb
AutoBrowser, Installation	116-AUTROBROWIN/DGB	autrobrowin_dgb
Datasheet: AutoMaster ISEMS	116-AMASTER-ISEMS/CGB	amasterisems_cgb

NOTE:

The display views, buttons, elements, mimics, colours and symbols used throughout this manual are configurable and based on examples. These may therefore not necessarily correspond to the actual ones used for a specific configuration.

2. AutoMaster ISEMS

2.1 Introduction

AutoMaster ISEMS is an Integrated Safety and Emergency Management System which can be used together with the AutoSafe Interactive Fire Detection System.



The AutoMaster ISEMS has an intuitive control and monitoring interface, providing an easy-to-understand graphical presentation of the premises and events that may occur. Navigation is fast and instinctual, and the powerful zoom functions allow you to monitor all areas in great detail.



The system can be connected to a large number of fire-alarm panels of different types (such as operator, control or repeater panels) via a serial connection or an ethernet network.

AutoMaster uses Linux¹ as an operating system.

Computer platform	Operating system	Comments
PC	CentOS 5.11	

AutoMaster functionality varies depending on which platform/ operating system it is running on, and whether it is connected to AutoSafe or Saia PLC.

In this handbook, the following symbols are used to indicate information relating to a specific operating systems and/or types of fire-alarm panel:

Symbol	Comments
	The function is only available for AutoSafe panels connected to AutoMaster.
	The function is only available for Autoprime panels connected to AutoMaster.
	The function is only available for BS-100 panels connected to AutoMaster.

Registered trademarks.





1) Linux is a registered trademark of Linus Torvalds.

Figures

The figures used in this handbook are diagrammatic and are intended to reflect the appearance that the user can expect, thus the content of the windows will be roughly the same for all platforms. Variation in appearance may occur due to customer-specific configuration, differences between platforms/operating systems.

2.2 AutroMaster Editions

AutroMaster ISEMS is the full AutroMaster edition, including all functionality. In addition, there are three editions; one for the oil & gas market, the maritime market, and the onshore market (see details in the overview below).

Functions/Modules	Oil & Gas	Maritime	Onshore	ISEMS
				
Basic functionality				
Fire management basic functions (AutroSafe, Autroprime 2.0.x or later, and BS-100 interface)	x	x	x	x
MultiSensor control	x	x	x	x
Report generator	x	x	x	x
Control and monitoring of emergency lights/LLL	x	x	x	x
Extended functionality				
AutroSafe IFG unit support	x	NA	NA	x
Dual Safety (AutroSafe 4.3 or later)	x	x	x	x
Touch screen support	x	x	x	x
Decision support system/incident manager				x
Electronic plotting table				x
Training/simulation module				x
Event record and replay module				x
Video module (live video support CCTV)	x			x
Remote connect function				x
Message center module				x
Interfaces				
Hernis CCTV interface				x
System-S interface				x
NMEA interface				x
VDR output		x		x
Modbus interface	x	x	x	x
ESPA 4.4.4 interface		x	x	x

3. Startup

Turn on the computer and monitor; the start-up process takes a few minutes.

When the start-up process is complete, the following screen- depending on the configuration – will appear:

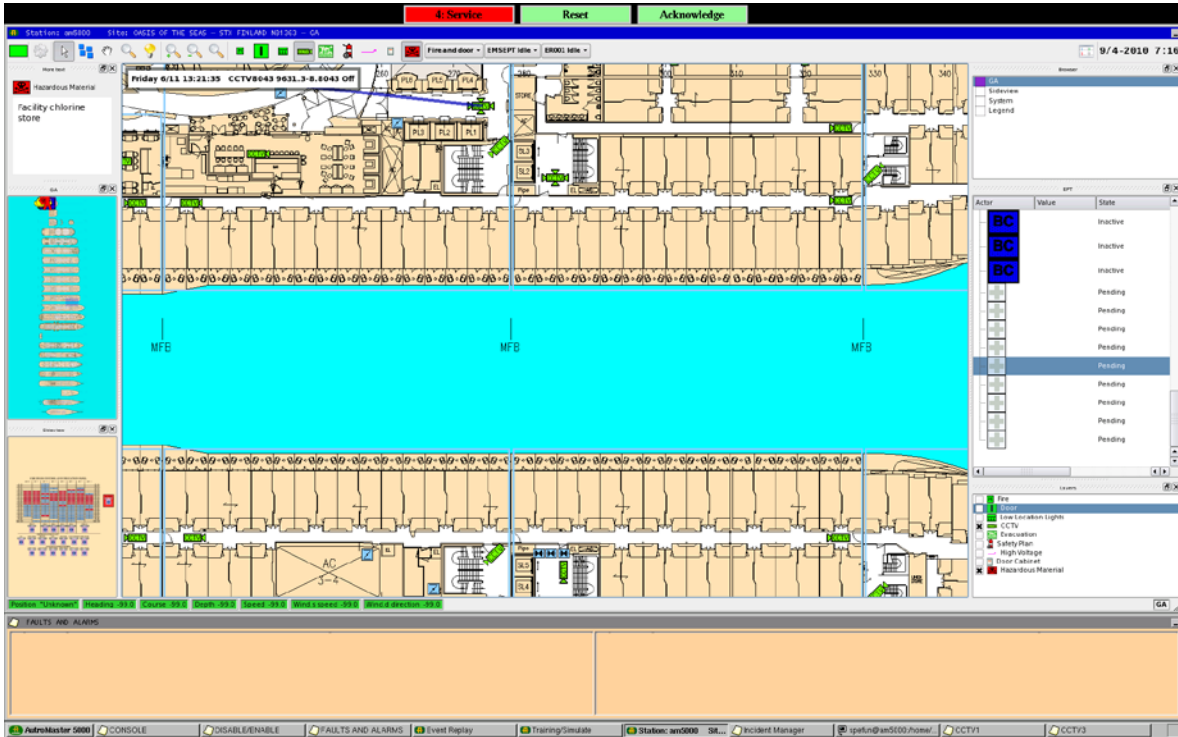

In this example, the graphical user interface AutoBrowser view is shown.

4. Graphical User Interfaces

4.1 Introduction

AutroMaster ISEMS provides the following two alternative graphical interfaces:

- Standard graphical user interface (default)
- AutoBrowser (introduced with AutroMaster ISEMS)

The graphical interfaces comprise display views, menu handling, buttons, panes, navigation techniques, system operating techniques, the change of mimics, the selection of points (detectors, manual call points, etc.).

For detailed information on each of these graphical user interfaces, see chapter 5 and 6, respectively.

NOTE:

The display views, buttons, elements, mimics, colours and symbols used throughout this manual are configurable and based on examples. These may therefore not necessarily correspond to the actual ones used for a specific configuration.

4.2 The Display

4.2.1 The Taskbar



The taskbar, by default, contains the following elements:

- AutroMaster
- Console
- Disable/Enable
- Faults and Alarms
- Event Replay (if included)
- Training/Simulate (if included)
- Presentation window (normally identified with a customer-specific title such as, for example, "Autronica").
- Incident Manager (if included)

AutroMaster (menu) gives users access to AutroMaster functionality, while the other elements refer to windows on the screen; AutroMaster maximizes/minimizes default windows automatically.

Note that the default windows cannot be closed. The taskbar may contain non-default programs and windows that have been minimized, these may safely be closed by the user.

AutroMaster: clicking this button reveals several options, these are described in chapter 8

Console: opens a window for system messages (normally runs in the background – does not require user interaction)

Disable/Enable: opens a window for overview and control of disablements and detector groups (normally maximized).

Faults and Alarms: opens a window for system faults (normally maximized), containing fault reports for system faults from AutroSafe or BS-100 fire-alarm systems, plus active alarms. The information is presented in the following format:

<Date/Time><Unit name><Fault Class/Type >

A fault can be acknowledge by right-clicking the mouse inside the window and selecting Acknowledge.

Presentation Window: the window which contains the customer-specific data and site mimic (normally maximized).

To return all windows to their original states and minimize non-default windows, select AutroMaster 5000 > Reset screen.

4.2.2 Menus at the Top of the Screen

The menus at the top of the screen allow control of access level, response to alarms and – if configured – Duty Control and Day/Night Control.

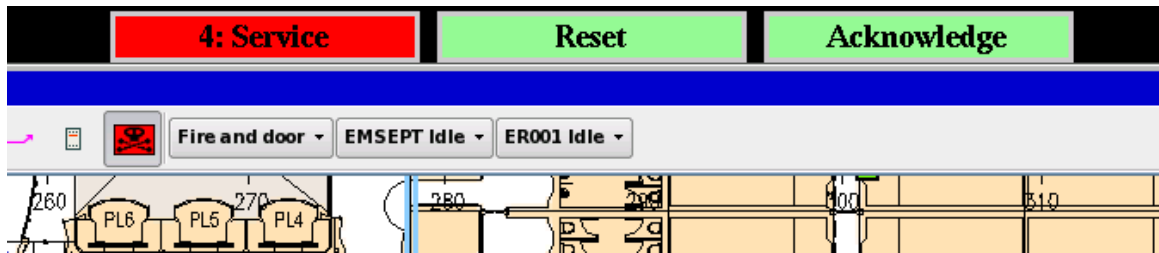

4.2.2.1 Day/Night Control – Display Dimming (if configured)

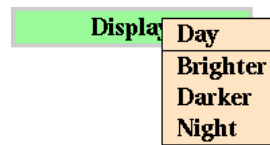

Applies to the standard graphical interface only.

Day/night control provides damping for light emission from the AutoMaster display. The menu contains settings for “Day” and “Night”; “Day” sets the display to full brightness, “Night” sets the display to minimal light emission. Two further options “Brighter” and “Darker” allow for adjustment between and outside these two settings.

4.2.2.2 Duty Control (if configured)

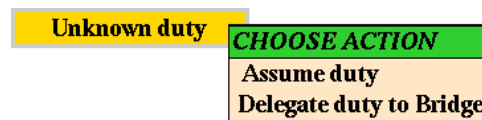

When two AutoMasters are connected together, duty control may be transferred from one machine to another. It is the operator with duty control who acknowledges/resets alarms.

Note: Duty control may only be transferred if the system comprises two machines connected together in a network and when duty control transfer is defined on both. On AutoMaster 5000s where no duty control is configured, this menu will not appear.

4.2.2.3 Security-Clearance Level/User Mode

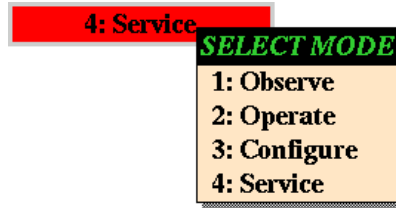

This menu changes to indicate the current security-clearance level of the operator.

Level	Name	Comment
1	Observe	Observation only.
2	Operate	Permission to disable/reset control panels and/or disable/enable detectors.
3	Configure	Permission to configure text messages, detectors, etc.
4	Service	Access to command-line functions.

To change security-clearance level: click and hold the menu label, and select a new security-clearance level.

A password is required to access higher security-clearance levels; enter passwords using either keyboard or mouse. No password required to change to lower security-clearance levels.

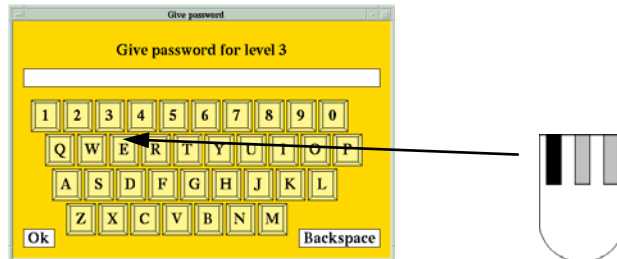

When changing to higher security-clearance levels, the password dialogue appears prompting the user to enter a password; do this by clicking the keyboard in the dialogue (using the left mouse button) or by using the keyboard. Click OK or press <RETURN> to confirm. Incorrect passwords result in an error message, entering a correct password gives access to the new security-clearance level.

4.2.2.4 Reset

The reset menu allows points to be reset; to do this, click a point to select it and choose Reset > Yes.

Selecting a point with the mouse and right-clicking with both the mouse reveals a menu. Points can also be reset from this menu by choosing Reset.

4.2.2.5 Acknowledge

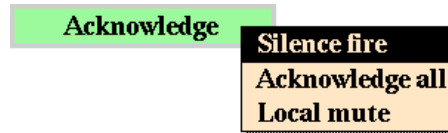

When a point in alarm is selected, this menu allows the following functions:

Acknowledge > Silence fire – all sounders are silenced.

Acknowledge > Acknowledge all – all alarms and faults are acknowledged

Acknowledge > Local mute – the PC buzzer is silenced.

4.2.2.6 AutoMaster Screensaver

In periods of inactivity, the AutoMaster screensaver (a moving Autronica product logo) is activated. The screensaver disappears as soon as the system mouse is moved.



4.3 System Operating Techniques

Note: All the processes described below presuppose use of the left mouse button, unless stated otherwise.

4.3.1 The Graphical System

All windows have the same basic format, with title bar and icons in the corners.



4.3.2 Moving a Window

- To move a window, move the cursor to the title bar, click and hold down the left mouse button and then drag the window to the desired position, then release the mouse button.

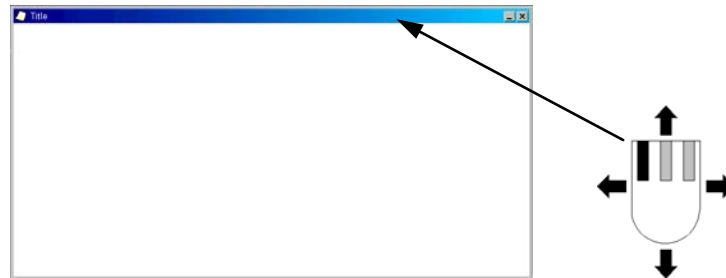

4.3.3 Minimizing and Closing Windows



This button is used to minimize windows.



This button is used to close windows/applications.

Note: Not all windows can be closed.

4.3.4 Resizing Windows

Windows can be resized by clicking, holding and dragging the window frame. When the cursor is moved to the correct position on the window frame, it changes to a double-headed arrow.

4.4 Overview – Loop Units/Point Menus

Loop Units	Point Menus																			
	Accept faults	Configuration	Disable/enable	History	Prolong delay	Reset single system	Re-sound single sys.	Silence single system	Temperature	Start/stop trending Gas Det.	Test mode on/off	Turn OFF	Turn ON	Turn ON LED <small>(Autoprime only)</small>	Close (config. option)	Open (config. option)	Change Perform. Class	Change Operat. Class	Activate LED**	
Alarm units†	x	x	x	x																
Alarm zones		x	x	x																
Outputs	x	x	x	x																
BS-320°	x	x		x																
BC-320°	x	x		x																
Modules*	x	x	x	x																
Manual call-points	x	x	x	x		x	x	x						x						x
Optical detectors	x	x	x	x		x	x	x						x			x			x
Heat detectors	x	x	x	x		x	x	x	x					x			x			x
MultiSensor	x	x	x	x		x	x	x	x					x			x	x		x
BS-100 detector ^a		x	x	x		x		x												
AutoBeam	x	x	x	x		x	x	x												
AutoFlame	x	x	x	x		x	x	x									x			
AutoSense	x	x	x	x		x	x	x												
Conventional loop interfaces	x	x	x	x		x	x	x												
Ionisation detector	x	x	x	x		x	x	x												
Misc. units‡	x	x		x																
BN-300	x	x	x	x		x	x	x												
BN-320 (e.g. fire-door control)	x	x	x	x		x	x	x							x	x				
BN-320/3 (e.g. LLL)	x	x	x	x								x	x							
BN-320/4 (e.g. std. control unit)	x	x	x	x								x	x							
BN-320/5	x	x	x	x		x	x	x												
Gas detectors, PowerLoop	x	x	x	x		x	x	x	x											
Detection zone	x	x	x	x	x	x	x	x		x	x									
Combined Point and DZ																				
BN-300/DZ	x	x	x	x	x	x	x	x		x	x									
Manual call-point/DZ	x	x	x	x	x	x	x	x		x	x			x						x
Optical detector/DZ	x	x	x	x	x	x	x	x		x	x			x			x			x
Heat detector/DZ	x	x	x	x	x	x	x	x	x	x	x			x			x			x
MultiSensor/DZ	x	x	x	x	x	x	x	x	x	x	x			x			x	x		x
AutoBeam/DZ	x	x	x	x	x	x	x	x		x	x									
AutoFlame/DZ	x	x	x	x	x	x	x	x		x	x						x			
AutoSense/DZ	x	x	x	x	x	x	x	x		x	x									
Gas detectors, PowerLoop	x	x	x	x		x	x	x	x											
Conventional loop interface/DZ hj	x	x	x	x	x	x	x	x		x	x									
Ionisation detector/DZ	x	x	x	x	x	x	x	x		x	x									
BN-320/5/DZ	x	x	x	x	x	x	x	x		x	x									

Notes: † Including: BBR-110, BBR-120, Bells, Loop Sounders, Alarm Zone

° AutoSafe only

* Including BSB-310/01, BSD-310/01, BSD-310/02, BSD-310/03, BSD-310/04, BSD-310/05, BSE-310

** Does not apply to Ex detectors

‡ Including: BU-200, BW-200, BW-2020, BW-203, GAPB

ª Including BS-100 detectors connected to AutoSafe via BSD-330.

4.4.1 Overview – Description of Point Menus

Point Menus	Description
Accept faults	Accept fault from units that report faults, marks fault as accepted in Alarms and Faults window
Configuration	Used in conjunction with History, Detector-group manager , Object list
Disable/Enable	Disable/Enable the point, adds the point to/removes the point from disablements list
History	Open the System history window for the selected point
Prolong delay	Prolong the delay between alarm levels
Reset single system	Reset the fire-alarm panel associated with the point
Re-sound single system	Re-sound the fire-alarm panel associated with the point
Silence single system	Silence the fire-alarm panel associated with the point
Temperature	Updates the point temperature-reading in the Information Pane
Start/Stop trending gas detector	Starts or stops trending of gas detectors connected to PowerLoop
Test mode off	Turn test mode off for the detector zone or combined point/ detector zone
Test mode on	Turn test mode on for the detector zone or combined point/ detector zone
Turn off	Activate the output
Turn on	De-activate the output
Close	Activate the output (e.g. fire doors)
Open	De-activate the output (e.g. fire doors)
Activate LED*	Activates the LED on a detector for a predefined period (default 5 seconds)

* Requires AutoSafe software version 4.8.

Point Menus	Description	Applies to
Change of Performance Class		
Clean Normal 1 Normal 2 Industrial	Change Performance Class to chosen class	Optical detectors and MultiSensors
A1 A1R A2S B C		Heat detectors
Class 1 Class 2 Class 3		Flame detector BG-201
Default		Return to default (Configured) Performance Class
Change of Operation Class		
Multi Only Heat Only Multi w/Heat	Change Operation Class to chosen class	MultiSensor
Default	Return to default (Configured) Operation Class	MultiSensor

4.4.2 Overview – Emergency Lighting

Units	Point Menus														
	Function test	Battery test (even addr.)	Battery test (odd addr.)	Battery test	Cancel test	Reset single system	Exit lights On/Off	System On	System Off	Disable Line 1	Disable Line 2	Disable Test	Enable Test	History	Configuration
Dardo2 panel	x	x	x							x	x	x	x	x	x
DardoPlus panel	x	x	x							x		x	x	x	x
OvaLight2														x	x
OvaLightPlus														x	x
OvaLine2														x	x
OvalinePlus														x	x
Gesslercentral	x			x	x	x	x	x	x					x	x
GesslerLine														x	x
GesslerLightMaintained														x	x
GesslerLightUnMaintained														x	x
GesslerLightLED														x	x
GesslerAnalog														x	x
GesslerCom														x	x

4.4.3 Overview – Description of Emergency Lighting Menu Items

Point Menu	Description
Function test	Tests the functionality of the system
Battery test (even addr.)	Starts battery-discharge test of armatures with even addresses
Battery test (odd addr.)	Starts battery-discharge test of armatures with odd addresses
Battery test	Starts battery test
Cancel test	Cancel tests in progress
Reset single system	Reset the emergency light panel
Exit Lights On/Off	Turn maintained lights on/off
System On	Activates all emergency lights (if they are deactivated)
System Off	Deactivates all emergency lights
Disable Line 1	Disables emergency power to Line 1
Disable Line 2	Disables emergency power to Line 2
Disable Test	Disables automatic tests
Enable Test	Enables automatic tests
History	Open the System history window for the selected point
Configuration	Used in conjunction with History, Detector-group manager, Object list

5. Standard Graphical User Interface

5.1 The Presentation Window

The AutoMaster presentation window provides the mimic function of AutoMaster; the mimic function is the graphical display of the alarmed area. The presentation window comprises:

- **Detail Pane:** displays the focused area of the mimic
- **Navigation Pane:** displays the entire mimic area, indicating current focus
- **Miscellaneous Buttons:** allow the user to switch to different mimics, and turn on/off information layers. The total number of buttons depends on the complexity of your system.

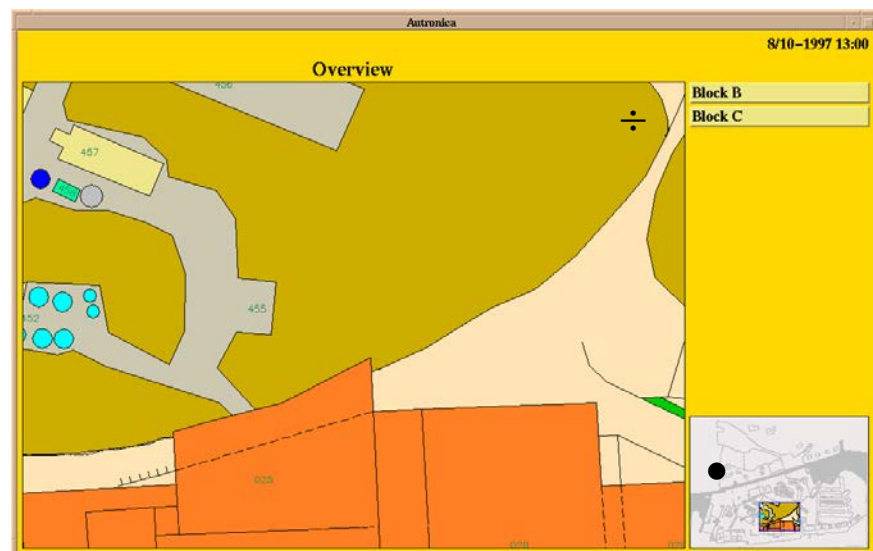

Buttons

The "Block B" button is used to change to a mimic of Block B.

The "Block C" button is used to change to a mimic of Block C.

5.2 Navigation Technique

There are three ways to navigate in AutoMaster.

A. Position the cursor in the Navigation Pane and left-click outside the frame that represents the focused area displayed in the Detail Pane.

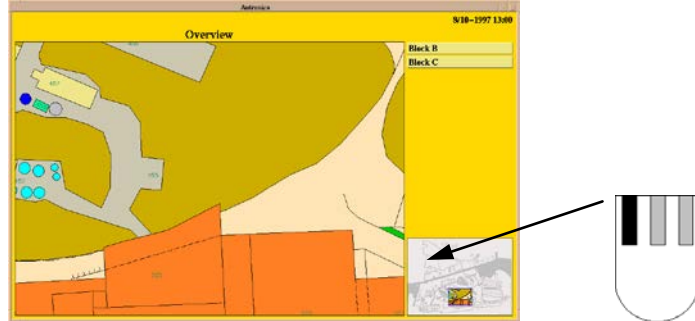

B. Position the cursor in the Detail Pane and hold down the middle mouse button while moving the mouse.

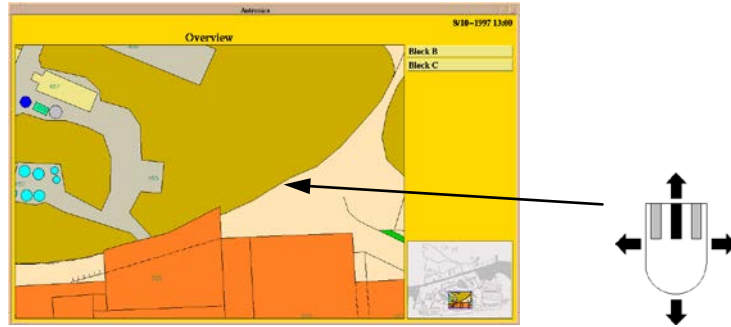

C. Position the cursor within the frame of the Navigation Pane and hold down the left mouse button while moving the mouse.



5.3 Changing Between Mimics

The system can contain many different mimics. In this example, the system contains 3 mimics.

Overview This picture provides an overview of the entire alarmed area.

Block B Alarm mimic for block B. This display contains all the floors and detectors in block B.

Block C Alarm mimic for block C. This display contains all the floors and detectors in block C.

The system can also include other mimics, especially land-based systems.

To change mimics, left-click one of the buttons on the right hand side of the pictures.



Overview A

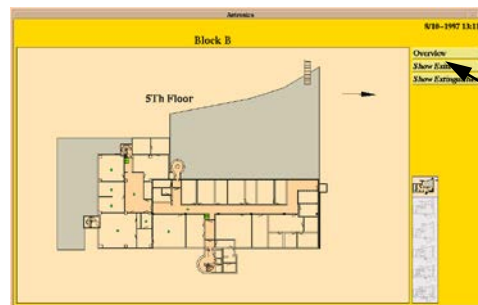

Block B

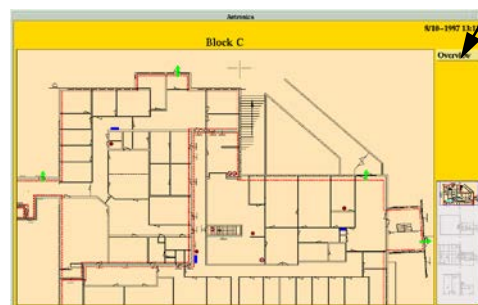

Block C



5.3.1 Select Areas

Selected areas or short-cuts may be defined in the picture. A short-cut is a technique for changing mimics by clicking on a specific area (which has been defined as a short-cut) in the mimic.



Left-click a specific area in the mimic.

Change to a specific building.

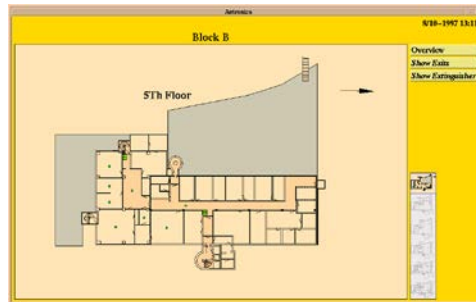

Note: A short-cut will only function when it has been defined.

5.4 Selecting a Detector or Point

5.4.1 Selecting Detectors

To read data from a detector, left-click the detector. The system automatically selects the nearest detector.

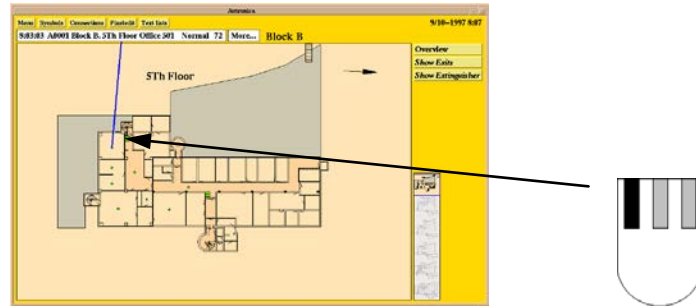

Additional information about the selected detector is presented in an Information Pane above the Detail Pane (the selected detector is indicated by a line linking it to the Information Pane). The Information Pane displays information in the following format:



8:03:03 A0001 Block B. 5Th Floor Office 501 Normal 72

This information should be read in the following way:

Text	Description
8:03:03	Date the detector status was last changed.
A0001	Detector number.
Block B. 5Th Floor, Office 501	Customer text (from BS-100)
Normal	Detector/Point status.
72*	Analogue value
(22C)	Temperature

The Information Pane may be followed by a button labelled More..., clicking this button makes the information dialogue appear with any programmed additional information, see section 5.4.2 below.

5.4.2 More Text for a Point

Detectors may have additional text attached. To view more text left-click More... to the right of the detector text.

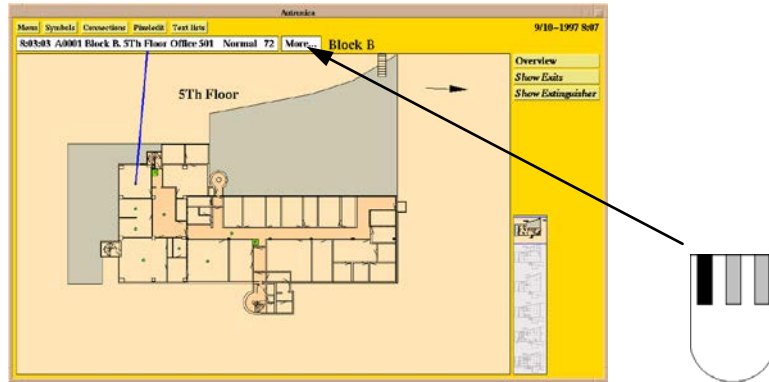

Left-click More... again to deactivate the text.

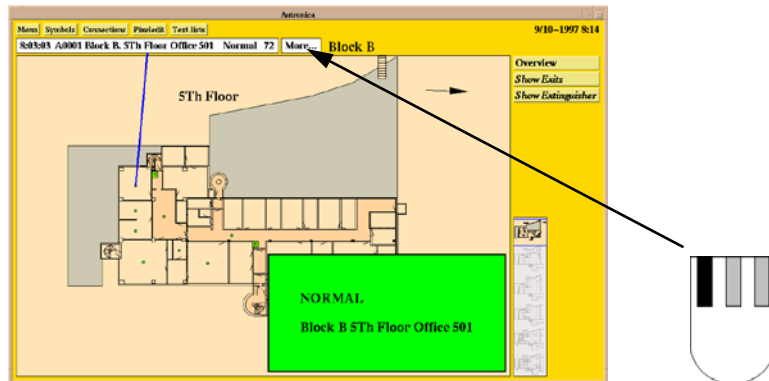

Additional text can be defined for the various statuses of a detector. Additional text for detectors in alarm, pre-warning, error and normal status are shown here.

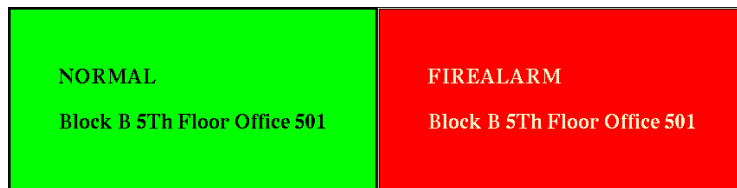

Text for normal status.

Text for alarm.

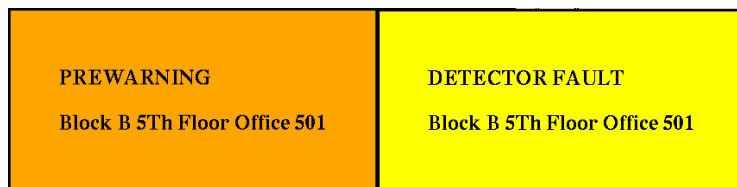

Text for pre-warning

Text for fault status.

5.4.3 Point Menu

All configured points have a point menu. There are two ways of accessing a point's menu;

- Right-click the point in question
- or
- Left-click the point in question (if not already selected), then left-click the Menu button at the top of the presentation window.

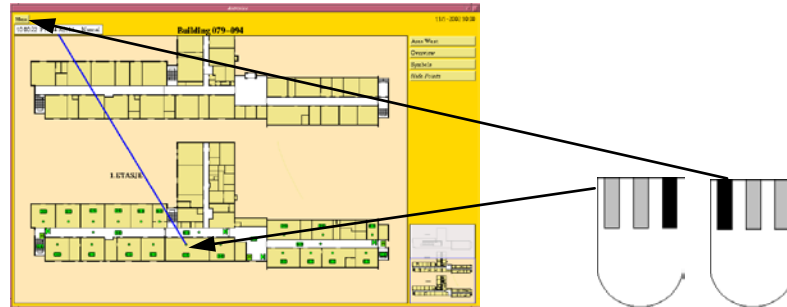

Note: point menus are user configurable; see project-specific documentation for further details. See section 4.4 for details of the possible menu options and their function.

5.4.3.1 Detectors, AutoSafe and BS-100

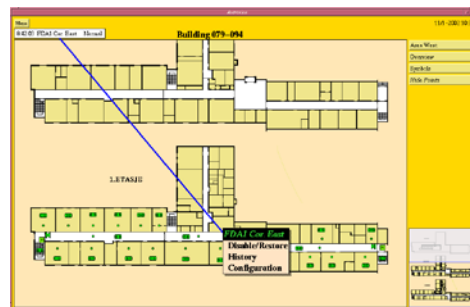

See section 4.4 for an overview of possible menu options.

6. AutroBrowser

6.1 Introduction

The AutroBrowser provides a user-friendly graphical interface, including various useful functions.

- Zoom; simple zoom functionality
- Movable/floating panes (move, rearrange and dock panes)
- High resolution graphics; suitable for widescreen/higher resolution and dual screen setups
- Drag and drop of Electronic Plotting Table (EPT) actors
- Multiselect of objects; define groups, disable/enable, trending, etc.
- Live video support; inputs to analogue CCTV (see chapter 20)
- Picture control
- Layer control

6.2 The Presentation Window

The AutoMaster presentation window provides a graphical display of the site. This graphical display is configurable, including various panes, buttons and elements for display control and navigation.

The presentation window includes (see illustration on next page):

- **Detail Pane:**
Displays the focused area (the area chosen in the Static or Dynamic Navigation Pane).
- **Static Navigation Pane:**
The Static Navigation Panel displays the entire mimic area. A small movable navigation box inside the pane is used to choose a focused area in the Detail Pane. There can be one or several of these panes.
- **Dynamic Navigation Pane:**
Displays the mimic that is selected in the Mimic control Pane. Mimics displayed are not configured as static navigation panes.
- **More Text Pane:**
Displays additional information (if configured) for the selected tag.
- **Status Bar (configurable):**
Tags can be displayed in the status bar, providing information on status and analogue values (for example, temperature 20°C)
- **Default Utility Buttons:**
Navigation, Multiselect, Zoom, Day/Night mode
- **Configurable Buttons:**
For example, to turn on/off information layers, to give easy access to important tags in the system, etc. The total number of buttons depends on the complexity of the system.
- **Mimic Control Pane:**
Pane showing all available mimics (both static and dynamic mimics).
- **Layer Control Pane:**
Pane showing all available layers (configurable). Checkboxes allows you to hide a layer or make a layer visible.
- **Electronic Plotting Table Actors:**
Displays all preconfigured actors. Each actor has its own symbol.
- **Information Pane**
Information for a selected point is shown in an Information Pane in the uppermost left hand corner of the Detail Pane (see example below).

8:03:03 A0001 Block B. 5Th Floor Office 501 Normal 72

The different panes, buttons and other elements are described in separate chapters.

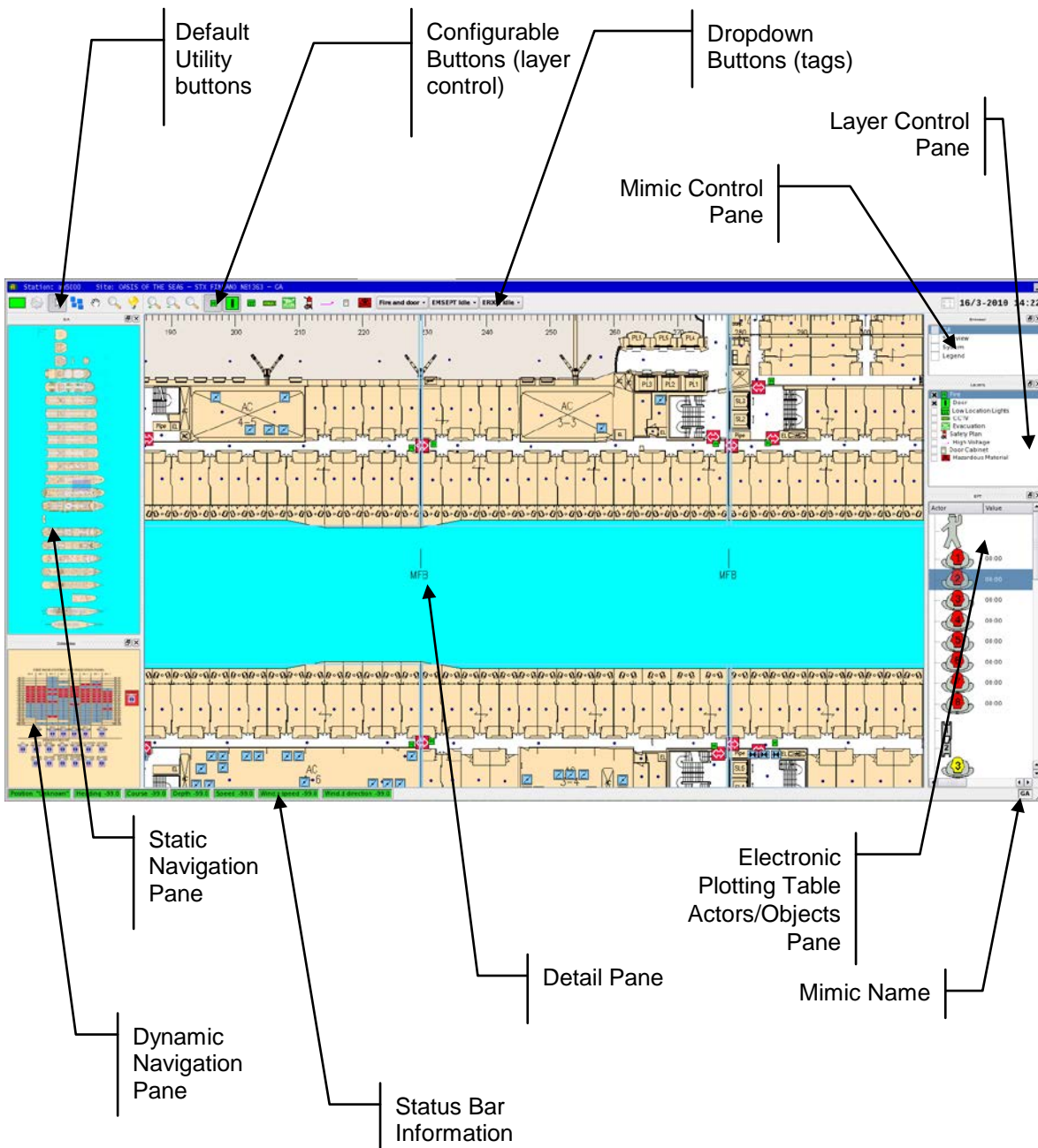

6.3 Detail Pane

The Detail Pane is the focused area, i.e. the area chosen in the Static Navigation Pane. It contains the customer-specific data and site mimic (normally maximized) and will always appear on the screen.

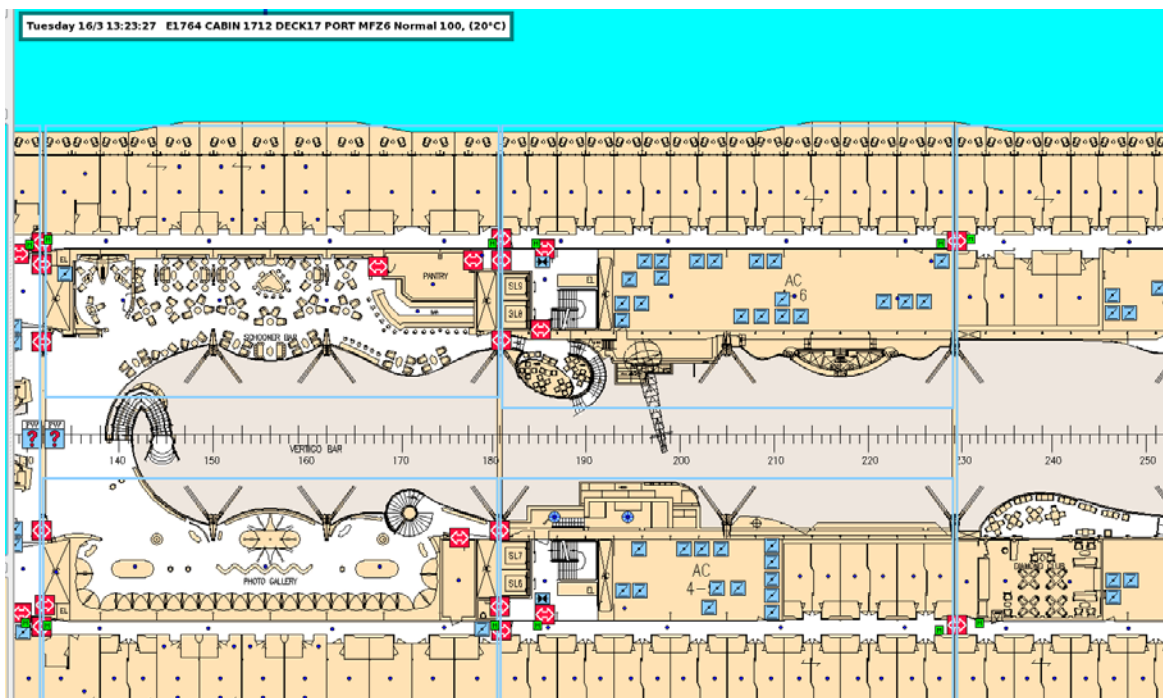

6.4 Static Navigation Pane

The Static Navigation Panel displays the entire mimic area and is always visible. A small movable navigation box inside the pane is used to choose a focused area in the Detail Pane. There can be one or several of these panes (configurable).

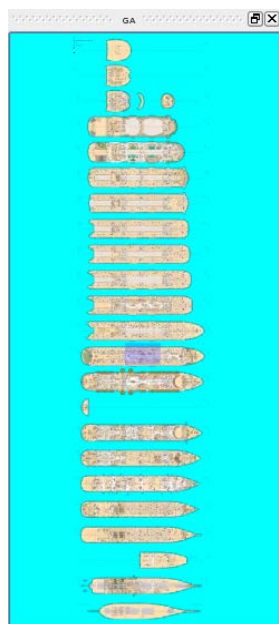

6.5 Dynamic Navigation Pane

The Dynamic Navigation Pane displays the last selected mimic (selected in the Mimic Control Pane).

When clicking inside the Dynamic Navigation Pane, the last selected mimic will be shown in full size.

Note that the Detail Pane (a selection in the Mimic Control Pane) will never appear in this pane.



6.6 Mimic Control Pane

The Mimic Control Pane (browser) shows all available mimics (both static and dynamic mimics).

- To select a mimic, position the cursor inside the pane, and left-click the box for the mimic in question. (In this example, the mimic "Legend" is selected).

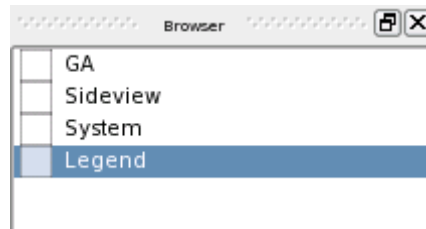

If there are many mimics, these can be organized and grouped in a tree structure (by configuration) which can be collapsed or expanded.

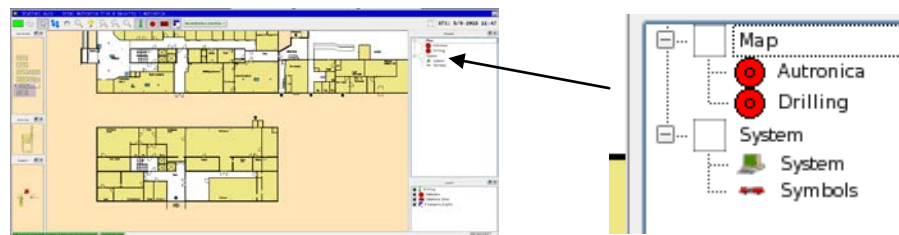

The colour of a mimic box will change to a different colour if a fault, a prewarning or an alarm situation occurs;

- fault: yellow
- prewarning: orange
- alarm: red

The box will also flash (accompanied by a audio signal) if a prewarning or an alarm situation occurs.

6.7 Layer Control Pane

The Layer Control Pane shows the available layers (configurable). Each layer is also represented by a button (see Configurable Buttons).

- To make a layer visible or hide a layer, left-click inside the layer's checkbox.

A mark inside a layer's checkbox indicates that a layer is visible in the Detail Pane and the Navigation Pane. In the example below, the layers "Fire" and "Door" are visible.

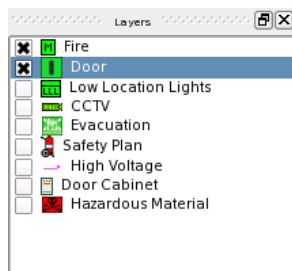

6.8 More Text Pane

During configuration, additional text can be added to a tag, and each status of a tag can be given a unique text.

The More Text Pane displays additional information for a selected tag (if configured).

The example below shows the More Text Pane for the tag "Hazardous Material".

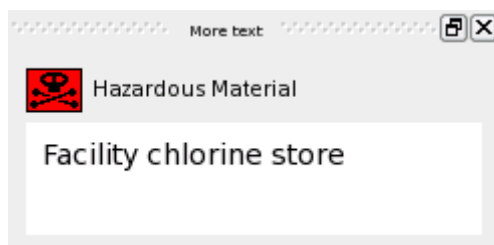

6.9 Pane Control Pane

The Pane Control Pane includes a checkbox list for all available panes in the configuration. Panes that are ticked off in the checkbox will be visible.



6.10 Status Bar (configurable)

Tags can be displayed in the status bar, providing information on status and analogue values (for example, temperature 20°C).



6.11 EPT Actors/Objects Pane

The EPT Actors/Objects Pane displays all preconfigured actors and objects used for the Electronic Plotting Table. Each actor/object has its own symbol. For detailed information, refer to chapter 27.2.

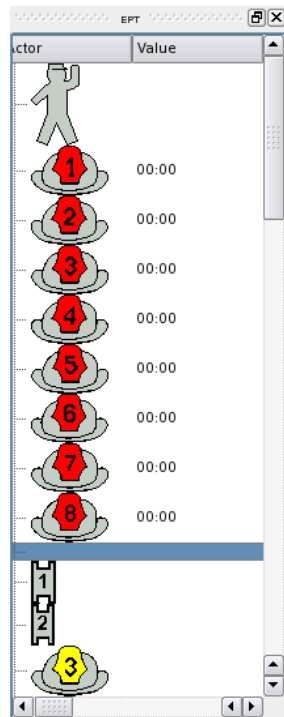

6.12 Default Utility Buttons

The overview below shows the default utility buttons.

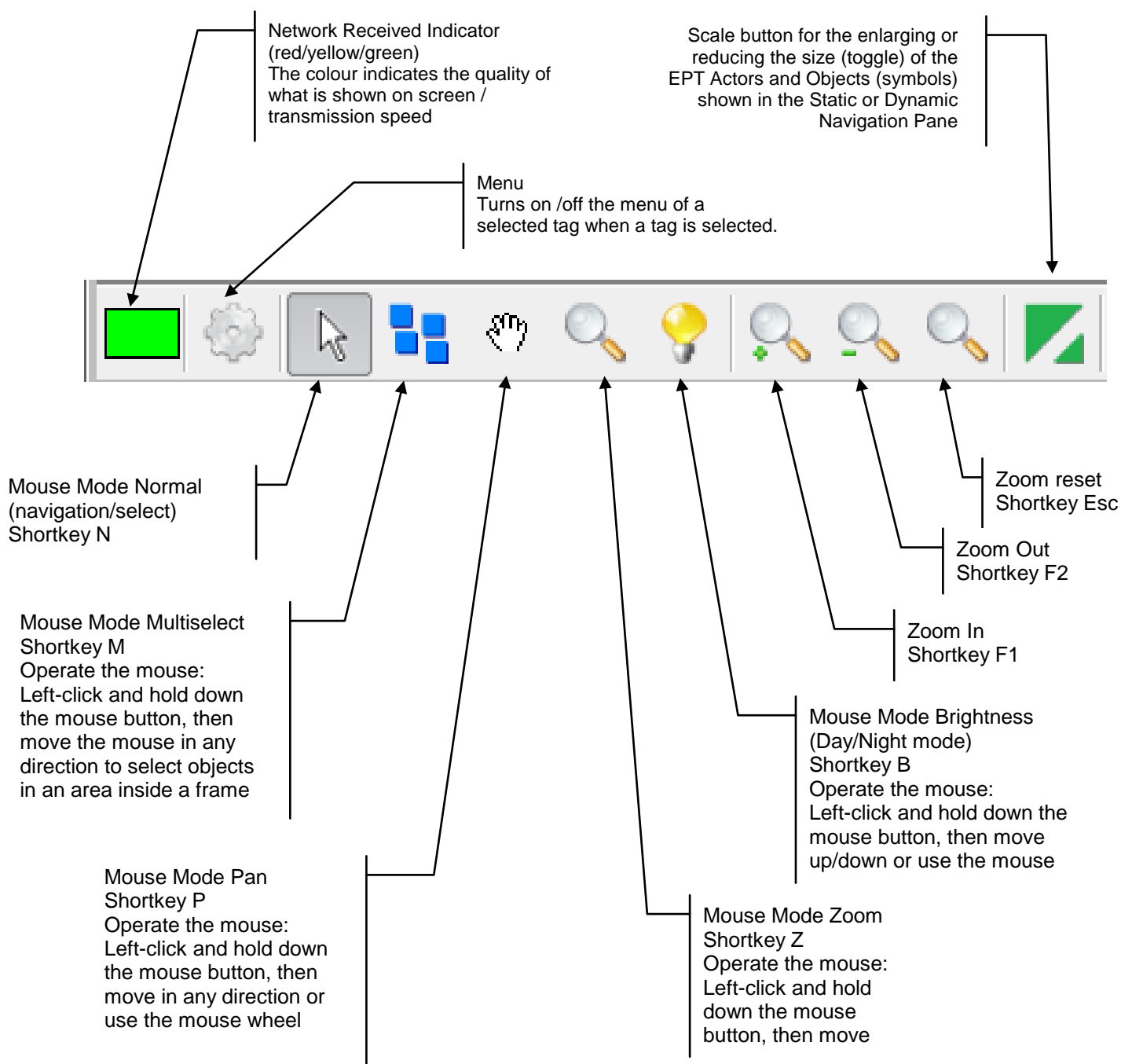

6.13 Configurable Buttons

In addition to the Default Utility Buttons, several Configurable Buttons can be added, for example, buttons used to turn on/off information layers (hide or make visible), buttons giving easy access to important tags in the system, etc.

The total number of configurable buttons depends on the complexity of your system.

The example below shows 9 buttons for layer control and 3 global command buttons with dropdown menus.



Layer Control Buttons used to hide a layer or make a layer visible
The same layers are listed in the Layer Control Pane (shown below)

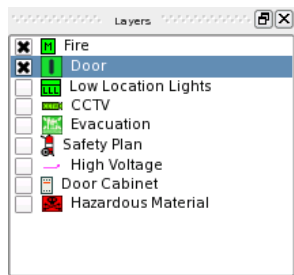

Global Command Buttons (examples) with dropdown menus.

The dropdown menus in this example are shown below.

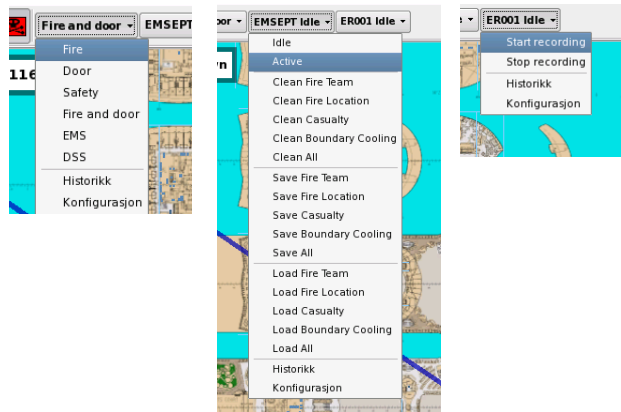

6.13.1 Shortkeys – Overview

Function	Key operation
Pan mode	Press and hold Ctrl
Zoom mode	Press and hold Shift
Horizontal scrolling	Press and holde Alt
Multiselect mode	Press S
Clear multiselect	Escape
Cancel (returns to Mouse Mode normal)	Escape
Zoom reset	Escape
Mouse Mode Zoom	z
Zoom in	F1
Zoom out	F2
Show the next Mimic in the Mimic Control Pane	F9
Show previous Mimic in the Mimic Control Pane	F10
Mouse Mode Normal (navigation/select)	n
Mouse Mode Multiselect	m
Mouse Mode Pan	p
Mouse Mode Brightness (Day/Night mode)	b

6.14 Quick Mouse Operation

In addition to shortkeys, quick mouse operation is possible using a combination of buttons, mouse click and mouse wheel.

6.14.1 Display a Mimic

- Click any mimic in the Mimic Control Pane or click inside a Navigation Pane (if available).

6.14.2 Scroll inside the Navigation Pane

Move around inside the Navigation Pane:

- Position the cursor inside the navigation Pane, click and hold the left mouse button, then move the mouse in any direction.

6.14.3 Scroll inside the Detail Pane

Move the Detail Pane in any direction:

- Position the cursor inside the Detail Pane, click and hold the left mouse button, then move the mouse in any direction.

Scroll the Detail Pane vertically (up and down):

- Position the cursor inside the Detail Pane, then use the mouse wheel to scroll vertically.

Scroll the Detail Pane horizontally:

- Position the cursor inside the Detail Pane, press Alt and use the mouse wheel to scroll horizontally.

Scroll the Detail Pane page by page:

- Position the cursor inside the Detail Pane, press Ctrl, then use the mouse wheel to scroll vertically page by page.

Scroll the Detail Pane page by page:

- Position the cursor inside the Detail Pane, press Alt + Ctrl, then use the mouse wheel to scroll horizontally page by page.

6.14.4 Zoom In/Out the Detail Pane

Zoom in and out

- Press and hold the Shift button. Use the mouse wheel to zoom in and out.

or

- Click the Mouse Mode Zoom button, click and hold the left mouse button, then move the mouse up or down.

6.14.5 Brightness Adjustment

To control the brightness;

- Click the Mouse Mode Brightness button, then use the mouse wheel to adjust the brightness (up darker, down brighter)

or

- Click the Mouse Mode Brightness button, click and hold the left mouse button, then move the mouse up or down.

6.15 Customizing the Layout

The layout can be customized in respect to:

- the position of each pane
- the size of each pane
- whether a pane is visible or hidden

Note that the Detail Pane cannot be moved or resized.

When all changes are done, the layout must be saved.

6.15.1 Rearrange Panes

The panes can be rearranged, i.e. moved and docked to any position.

- Position the cursor on the uppermost part of the pane (near the heading of the pane), and hold down the left mouse button while moving the mouse to another position.
- When the pane is placed in its desired position, release the left mouse button.

The pane will snap to the desired position (in the example, the pane will snap to the position in the direction the arrows are pointing). The panes nearby this position will automatically be reduced in size when the pane is moved towards its position.

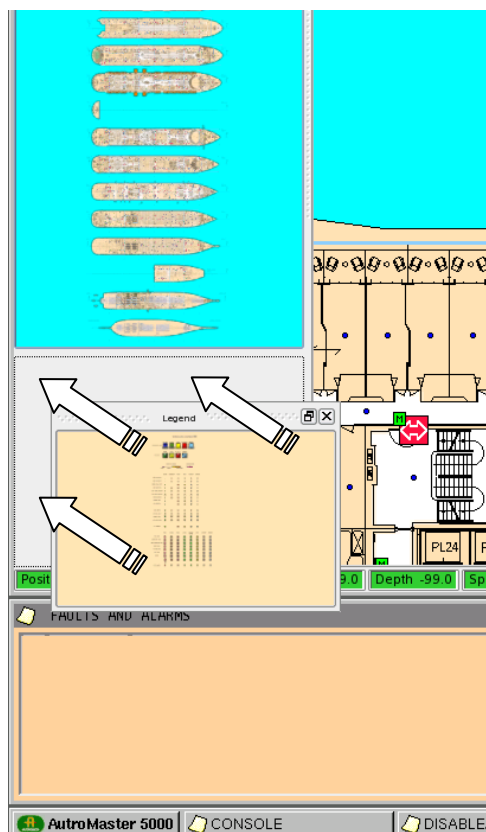

6.15.2 Resize Panes

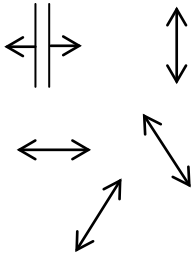

The panes can be resized.

- Position the cursor close up to the pane's outside frame (a resize symbol will appear), and hold down the left mouse button while moving the mouse
 - up/down to resize vertically
 - left/right to resize horizontally
 - up/down diagonally to resize vertically/horizontally
- When the pane is resized as desired, release the left mouse button.

6.15.3 Hide or Make Panes Visible

The panes can be hidden or they can be made visible.

- To hide a pane, click the cross in the uppermost right corner of the pane.
- To make a pane visible, position the cursor on the uppermost part of the pane (near the heading of the pane), then right-click.

A checkbox (Pane Control) will appear, showing all available panes.

- Tick off the panes you want to make visible.

6.15.4 Save layout

When all changes are done, the layout must be saved.
To save a layout, the Service access level is required.

- Position the cursor on the Save Layout symbol on the uppermost right hand side of the screen (close to and on the left side of date and time).



- Click the left mouse button.

A dialogue box will appear.

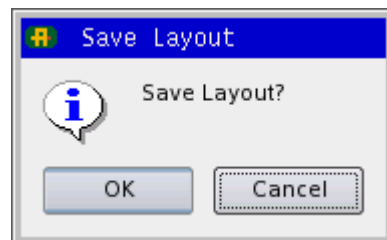

- Click OK to save the new layout.

6.16 Operating Techniques – Using Touchscreen Functionality

6.16.1 Default Utility Buttons

All default utility buttons are designed for touchscreen.



6.16.2 Mouse Mode Normal (navigation/select)



- Point at the button.
- To select an object inside the Detail Pane, point at the object.
- To scroll, point a certain distance away from an object (the grab symbol will appear), then scroll.

6.16.3 Mouse Mode Multiselect



- Point at the button.
- Point anywhere inside the Detail Pane, then hold down the left mouse button and move in any direction to create a frame that includes the objects you want to select.

6.16.4 Mouse Mode Pan



- Point at the button.
- Point anywhere inside the Detail Pane, then move in any direction.

6.16.5 Mouse Mode Zoom



- Point at the button.
- Point anywhere inside the Detail Pane, then move up to zoom out or move down to zoom in.

6.16.6 Mouse Mode Brightness (Day/Night mode)



- Point at the button.
- Point anywhere inside the Detail Pane, then move up for a brighter view or move down for a darker view.

6.17 Selecting Mimics

The system can contain many different mimics. The Mimic Control Pane (refer to chapter 6.6) shows all available mimics (both static and dynamic mimics). All mimics are also shown by right-clicking the top frame of any pane.

Short-cuts can be defined for specific areas inside the Detail Pane (normally configured in land-based installations). When left-clicking such an area, a more detailed mimic of the location will appear automatically. Short-cuts are included in the Mimic Control Pane as well, and can be accessed from this pane.

In this example, the system contains 3 mimics.

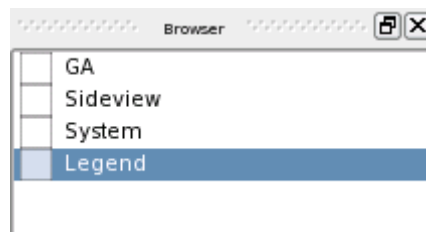

- **GA**
An overview of the entire alarmed area

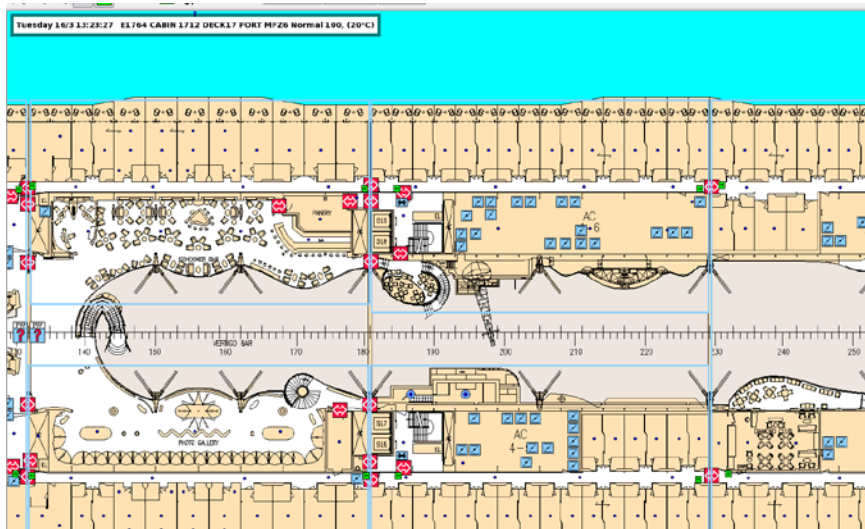

- **Sideview**
An overview of the fire door control and indication panel

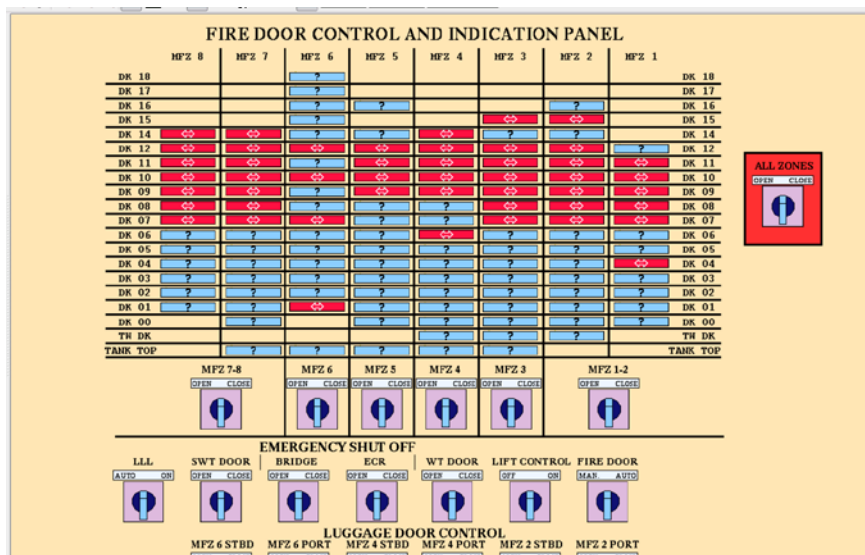

■ **System**

The system configuration / structure including all AutoMaster units and fire detection panels.

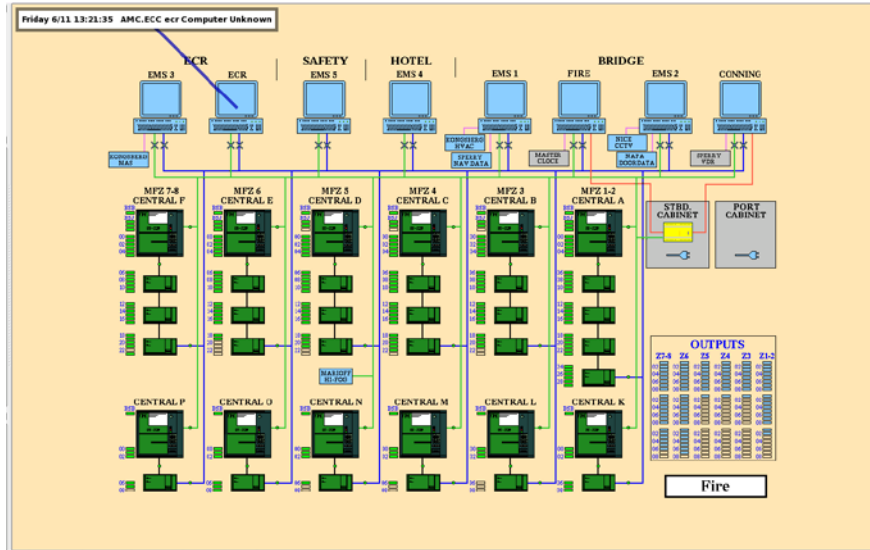

■ **Legend**

An overview of all symbols used in the system

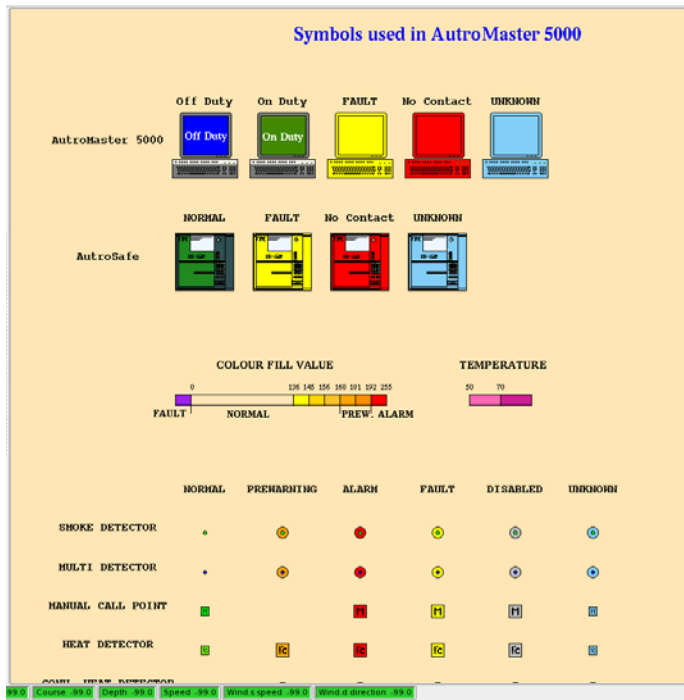

6.18 Selecting Detectors

- To read data from a detector, left-click the detector in question.

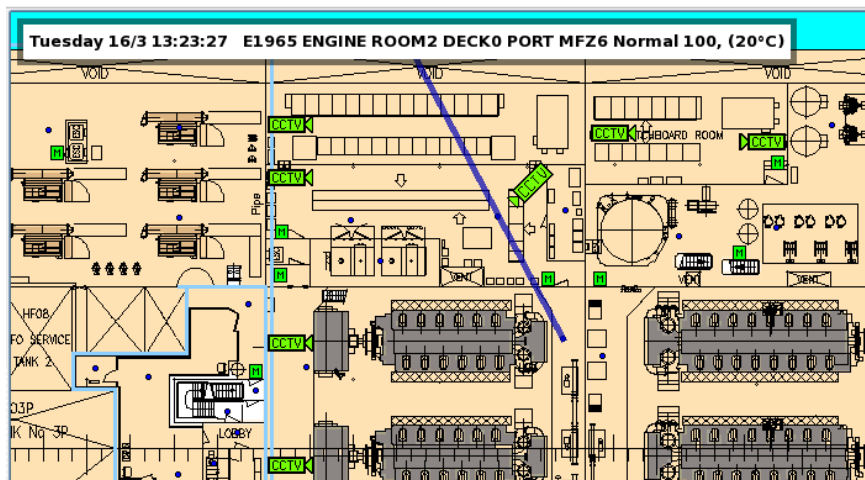

The system automatically selects the detector that is nearest the position of the cursor.

Information for the selected detector is shown in an Information Pane in the uppermost left hand corner of the Detail Pane. The selected detector is indicated by a line linking it to the Information Pane. The Information Pane displays information in the following format:

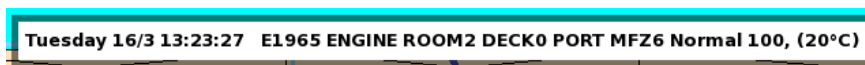

This information should be read in the following way:

Text	Description
Tuesday 16/3 13:23:25	Date and time the detector status was last changed.
A2855	Detector number.
DATA RACK DECK11 STB MFZ1	Customer text
Normal	Detector/Point status.
100	Analogue value
(20°C)	Temperature

6.19 Accessing Point Menus

All configured points have point menus.

- To access the menu for a selected point, right-click the point, or use the menu button  at the top of the presentation window.

The example below shows the menu for a selected detector.

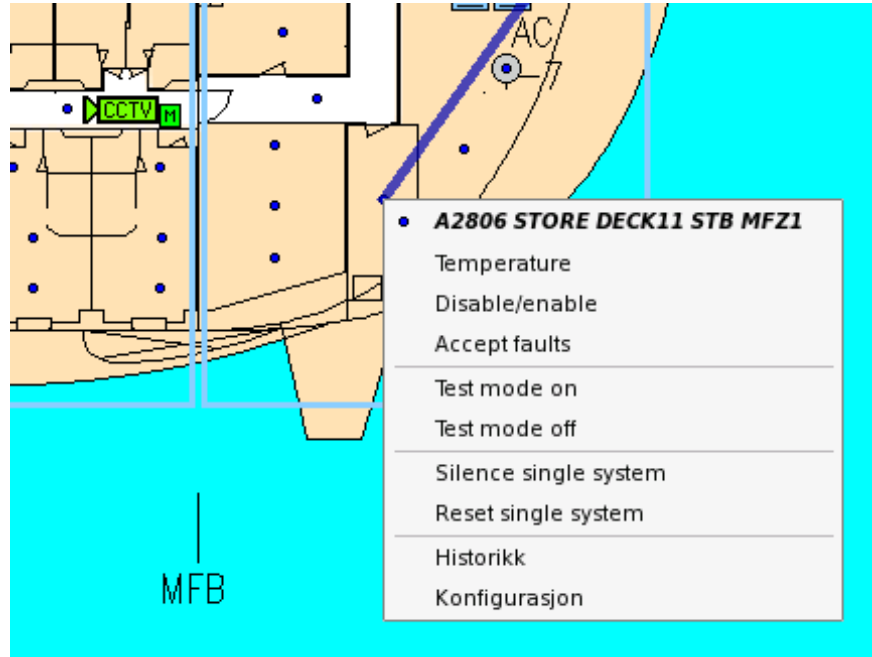

7. Alarm Situation

7.1 In the Event of an Alarm

When an alarm is given, an alarm window will automatically appear accompanied by an audio signal. The system will also show any additional text attached to the detector giving alarm.

In the event of alarm, the following procedure should be followed:

- Investigate the alarm location.
- Deactivate the alarm sounders on the control panels by clicking the Silence button.
- When it is safe to reset the control panels, click and hold the Reset menu and choose Yes.

Note: This is only a guideline for operating fire-alarm control panels in alarm situations. In most instances, the operator must follow local procedures for dealing with alarms.

Alarm display

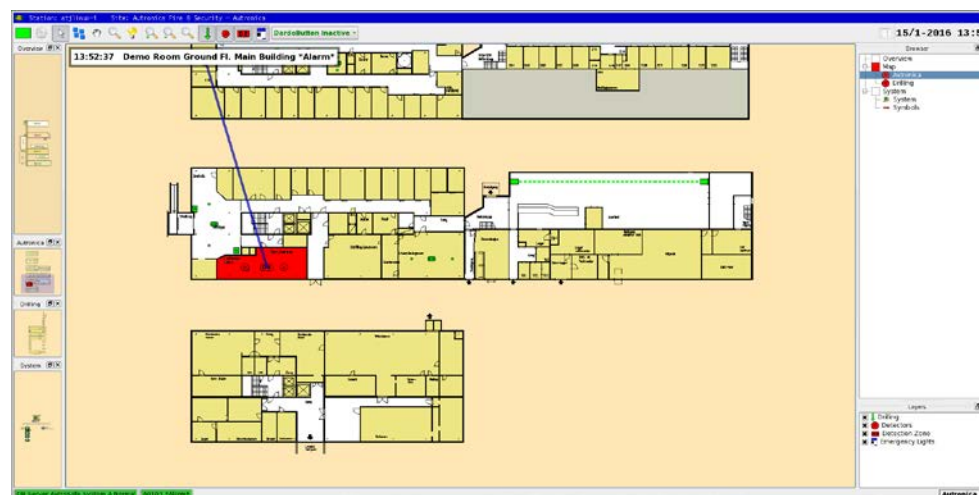

When an alarm is given, the mimic will alter to indicate the alarm location. The Detail Pane will show a flashing detector until you click the "Silence" button. The Information Pane will show the analogue value of the detector, and this information will also be marked in red in the room/area where the detector is located (providing that this is defined).

Investigate the alarm location

Check the alarm location to see whether there is a fire.

Silence the alarm



Silence the alarm by choosing Acknowledge > Silence fire. The detector status will change from a flashing symbol to a static symbol, and the detector in the reference display will disappear.

Reset the fire-alarm control panel

Reset the control panel choosing Reset > Yes. The system will return to normal operation after an interval of a few minutes.

Pre-warning and detector error

Pre-warnings and detector errors are indicated in the same way, except that there are no changes in the mimic.

Colours are used in the following way in the event of an alarm situation:

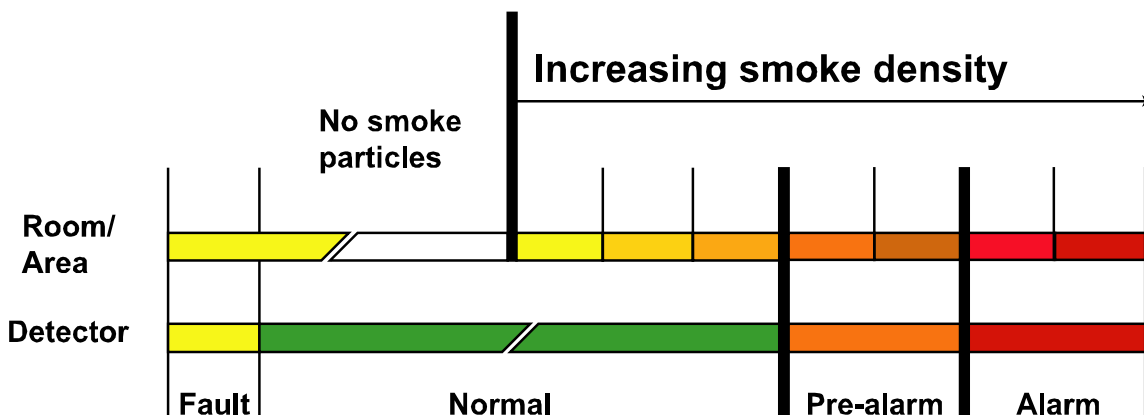

7.2 In the Event of Several Alarms

If more than one alarm is given, the alarm list in the lower right corner of the display can be used to see which order the alarms appeared in. Details of the activated alarms can be obtained by clicking on the various lines.

- Change to another alarm.



- Click on alarm 2.

The display changes from the 1st. to the 2nd. alarm.



- Return to the first alarm.



- Click on alarm 1

The display returns to the first alarm.

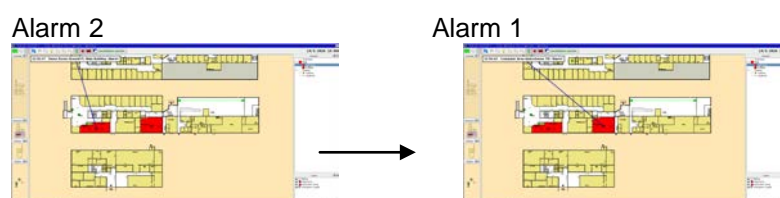

8. AutroMaster Menu

The AutroMaster Menu provides access to numerous operator-functions.

- Click AutroMaster and choose the required function.

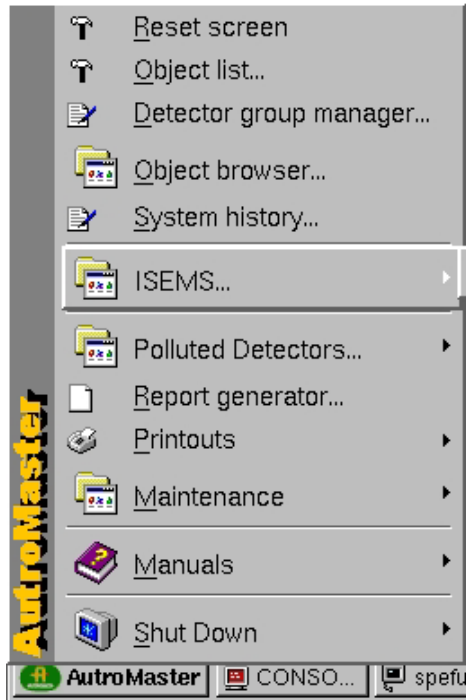

8.1 Reset screen

Reset screen restores the default windows to their default positions, helping to manage open windows in the AutoMaster workspace. This function also restores security-clearance level 1 (Observe).

This function does not, however, close Command-line windows (as they may be controlling important maintenance processes that will be disturbed if the window is closed), but minimizes them. In applications where security is paramount, it is important that all command-line windows are closed before resetting the screen.

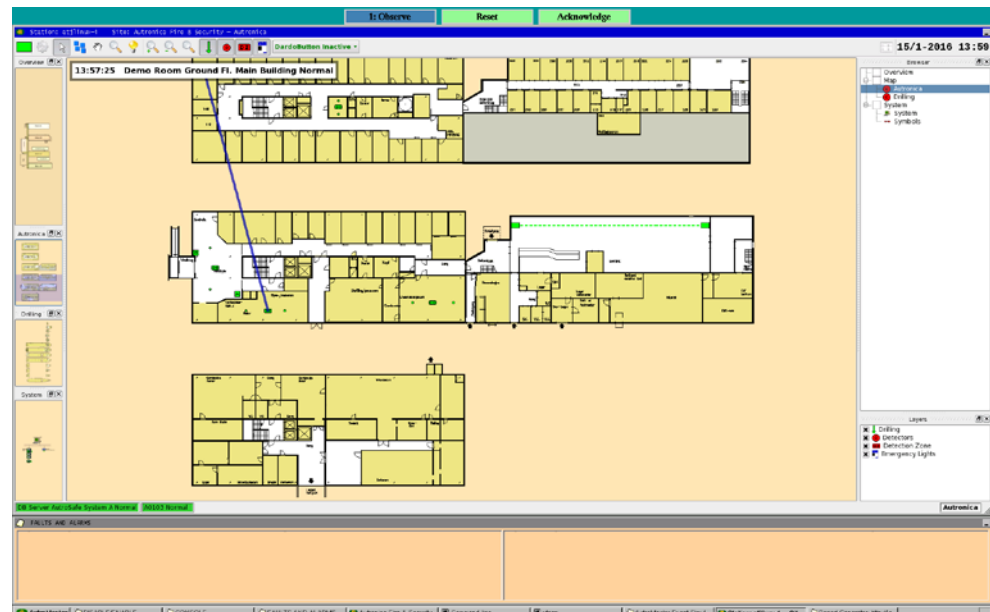
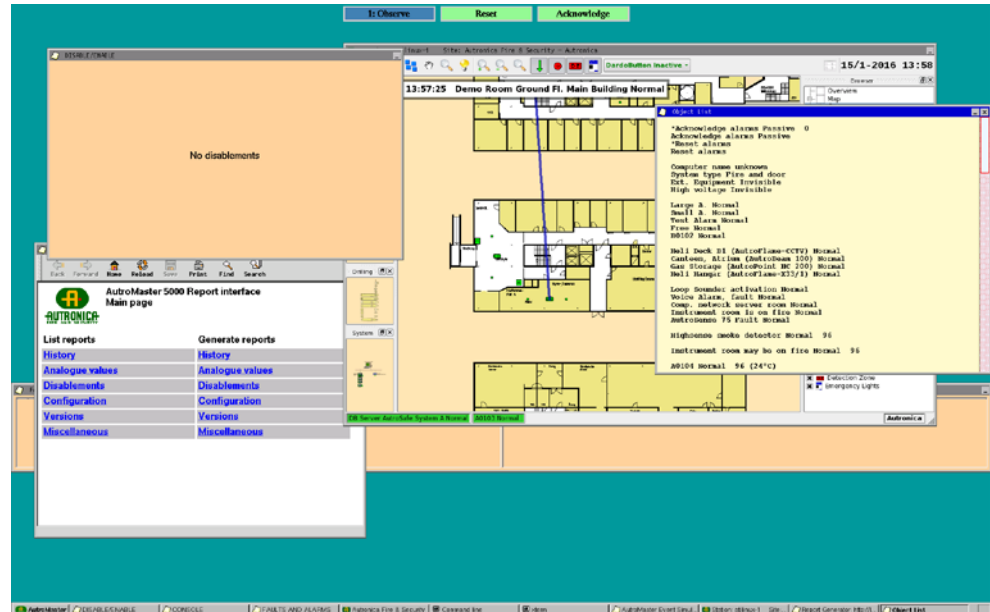

Please observe

AutoMaster may also be configured to reset the screen each time the screensaver starts. For more information, please refer to the installation and commissioning handbook.

8.2 Object list

Object list describes all detectors and other active units in the system in text form. Each detector or loop unit in the system corresponds to an object entry: a line of text with detector number, descriptive text, status and analogue value, if such is available.

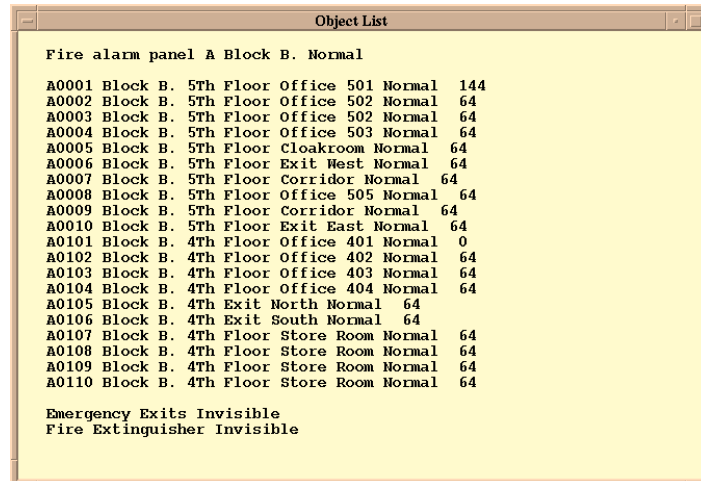

8.2.1 Functions in the Object List

Clicking an object entry in the object list provides access to a number of functions via a point menu, see section 4.4.

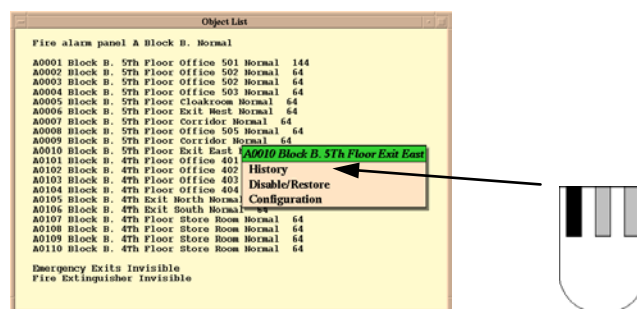

For further explanations of the menu items, see the following chapters:

- History
- Disable/enable
- Configuration

8.3 Network topology BS-100



Network topology BS-100 provides a visual overview of BS-100-based systems. The overview includes fire-alarm control panels, detectors and other loop units connected to AutoMaster.

Note: security-clearance level 2 (Operation) is required to access this function.

Note: Network topology BS-100 does not function with BS-100 loops connected to AutoSafe via BSD-330.

8.3.1 Functions in Network topology

Network topology allows a number of operations to be performed, this section describes the user-interface for these functions.

8.3.1.1 Zooming in Network topology

It is possible to zoom the view in Network topology, so that all control panels and detectors are displayed. Simply click the right mouse button within the background of the Network topology window (not on a control panel or detector).

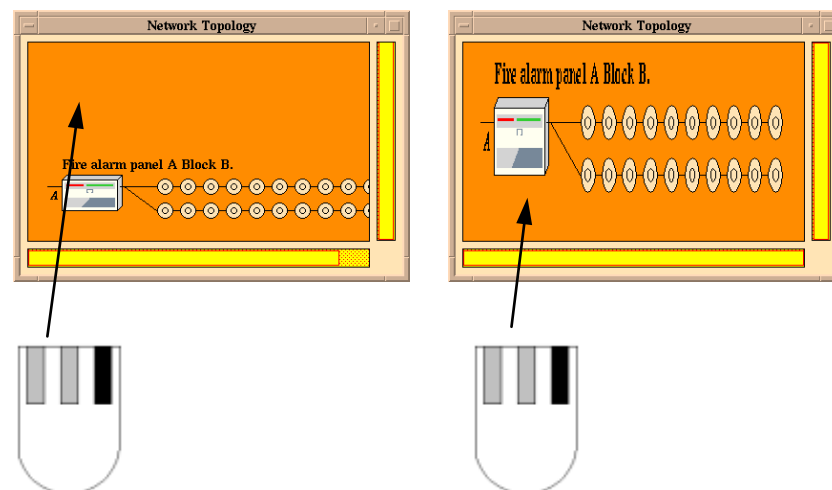

Note: You are advised not to use this function in large installations as there will not be sufficient space in the window to show all components clearly.

8.3.1.2 Selecting a Fire-Alarm Panel

- Click the fire-alarm panel symbol to select a particular fire-alarm panel; an information window will appear showing how many loops and detectors are connected to the selected fire-alarm panel.

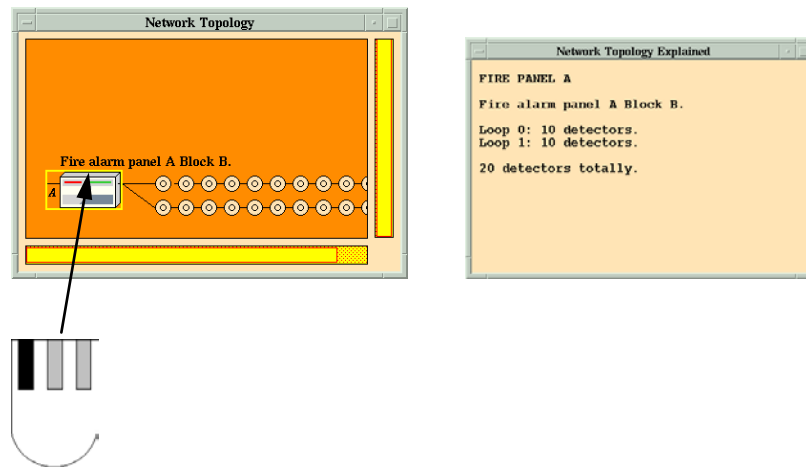

8.3.2 Functions in the Information Window for Control Panels

Click-holding the left mouse button in an information window causes a menu to appear. This menu contains the following functions:

- Silence
- Reset
- Analogue values

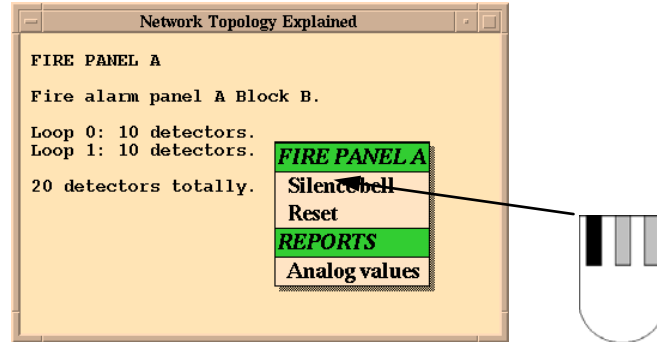

Silence disables the alarm sounders connected to the selected fire-alarm panel.

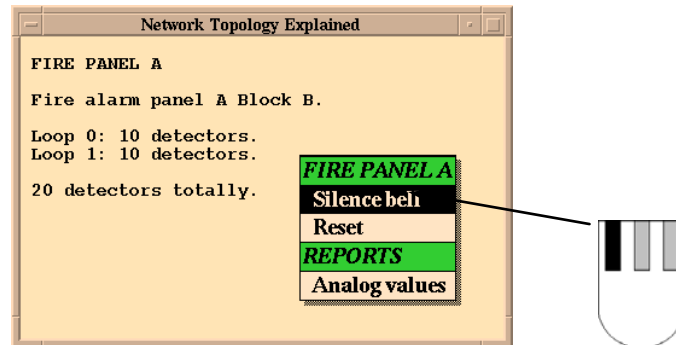

Reset resets the selected fire-alarm panel.

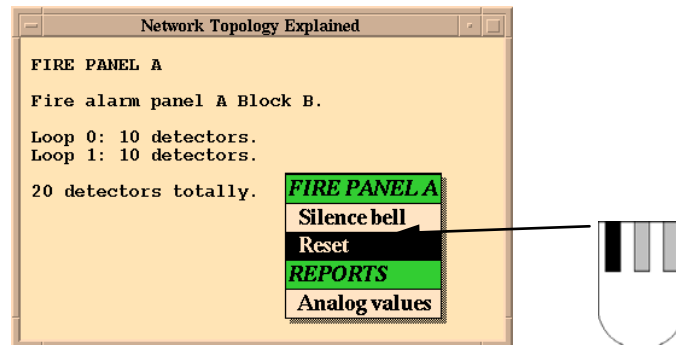

Analogue values causes the analogue value of all detectors connected to the selected fire-alarm panel to be displayed.

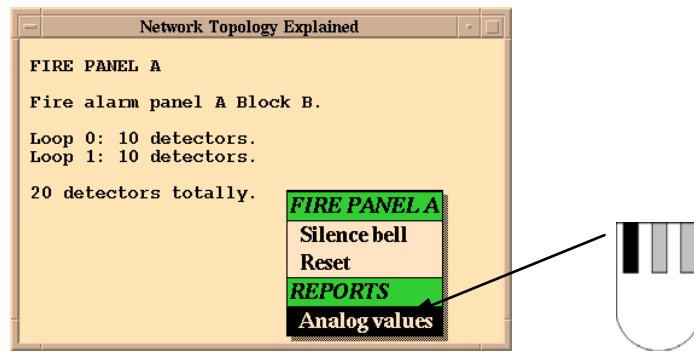

It is possible to change the limit values for Analogue values by click-dragging the limit marks to the required values and releasing the mouse button.

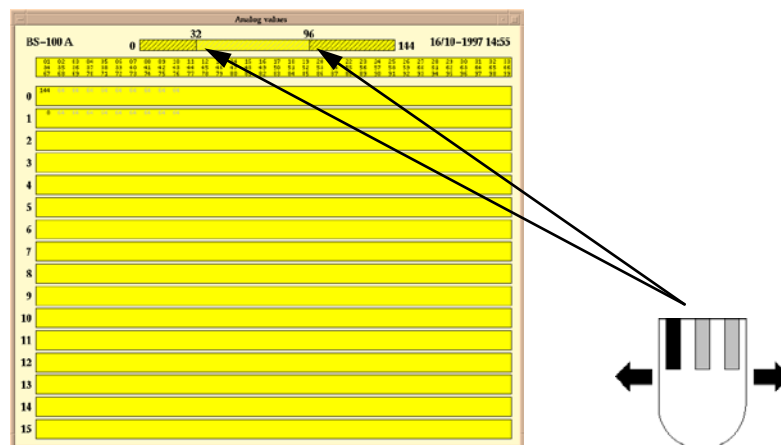

Section of values

0	144	0	0	0	0	0	0	0	0	0	0	0	0	0	0
1	0	0	0	0	0	0	0	0	0	0	0	0	0	0	0

Values in grey: normal values within the limit values.
 Values in black: values outside the limit values.

When the values are shown in a box, this means that the associated detector(s) is(are) disabled.

8.3.2.1 Selecting a Detector

A detector can be selected by clicking its symbol in Network topology; an information window will open showing details of the selected detector.

The information takes the following format:

- Status: Status of the detector
- Analogue value: The detector's analogue value
- Text: Customer-specified text relating to the detector

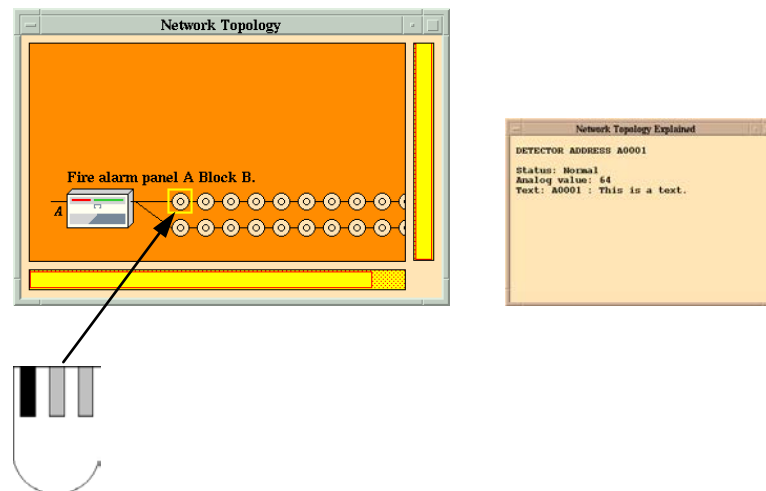

8.3.2.2 Functions in the Detector Information Window

Click-holding the left mouse button in an information window causes a menu to appear. This menu contains the following functions:

- Get last analogue values
- Disable
- Enable

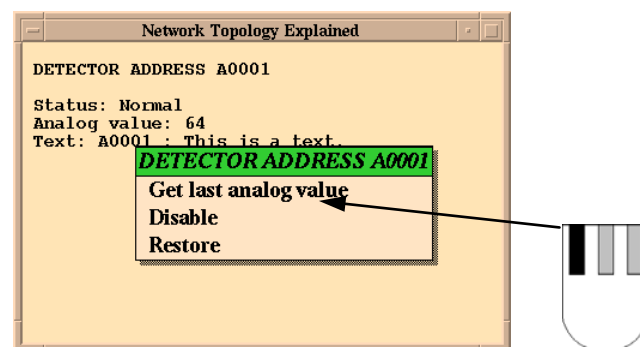

Get last analogue value will update the analogue value for the selected detector.

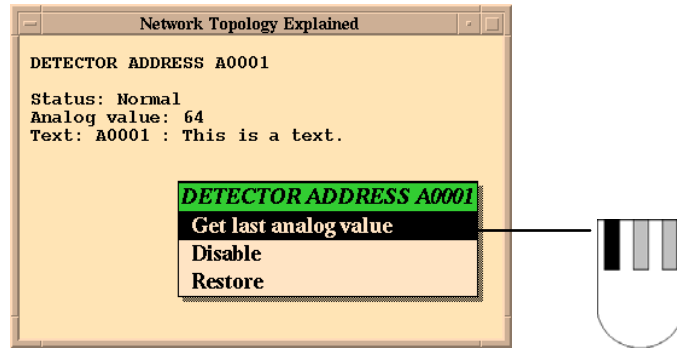

Disable disables the selected detector; If a detector is disabled using this menu, the detector will be permanently disabled. Disabled detectors can nevertheless have operations performed on them as described previously.

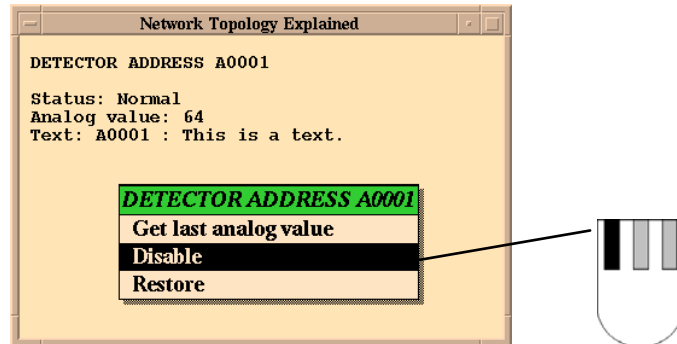

Enable is used to enable selected detectors.

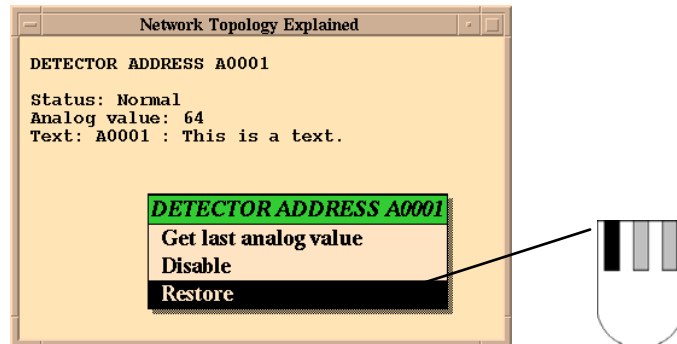

History provides the history of the selected detector or other unit. See chapter 10 for details of operation.

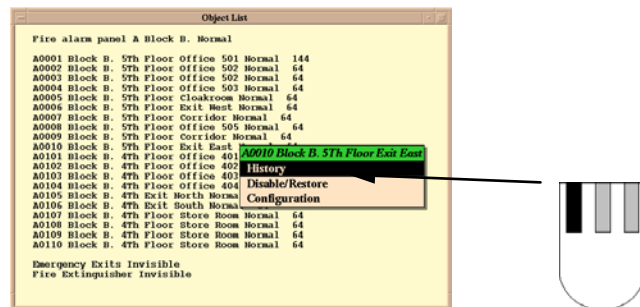

Disable/enable either disables or enables a detector (depending on its initial status (disabled/not disabled)).

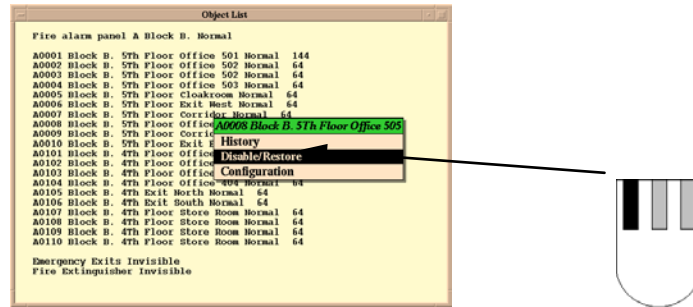

Security-clearance level 2 is required to use this function.

Configuration has 3 functions, depending on other functions activated on the system.

1. If the Object Browser is activated, Configuration adds the point to the Object Browser.
2. If the Detector group manager is activated, Configuration add the point to the active group.
3. If neither the Object Browser nor the Detector group manager is active, Configuration focuses the point in the Detail Pane.

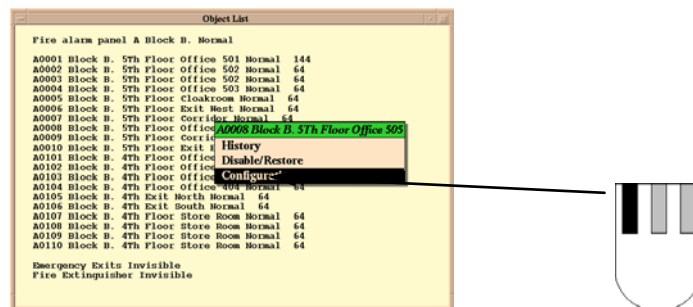

For more information about this menu, please refer to chapter 5.4.3.

8.4 Detector group manager

Detectors may be grouped together so that a whole group can be disabled simultaneously instead of having to treat each detector individually.

Note: security-clearance level 2 (Operate) is required to be able to group detectors.

The following table gives an overview of which points can be grouped:

System	Points which can be grouped
BS100	Detectors
AutoSafe	Detectors, Detection Zones, Loop Sounders, Alarm bell outputs, output controls, alarm and fault output

8.4.1 Creating Groups

- Click New group in the detector groups window.

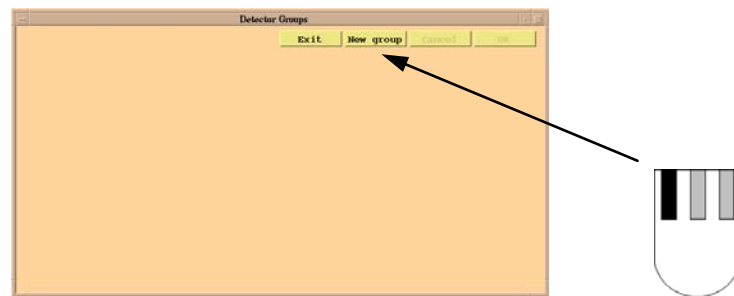

- Enter a name for the group and press <ENTER>.



8.4.2 Adding Detectors from the Graphic Display

Detectors can be added from the Detail Pane by clicking the required detector, holding down the left and middle mouse buttons and choosing Select from the point menu that appears.

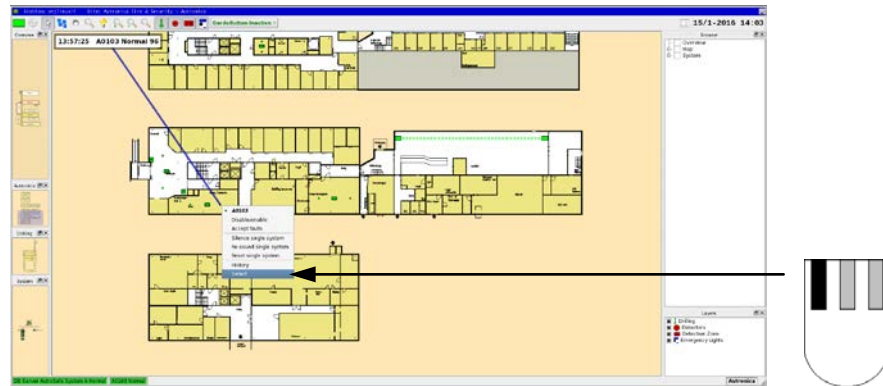

8.4.3 Adding Detectors from the Object list

Detectors can be added from the Object list by click-holding the left mouse button on an object entry and choosing Configure from the subsequent point menu.

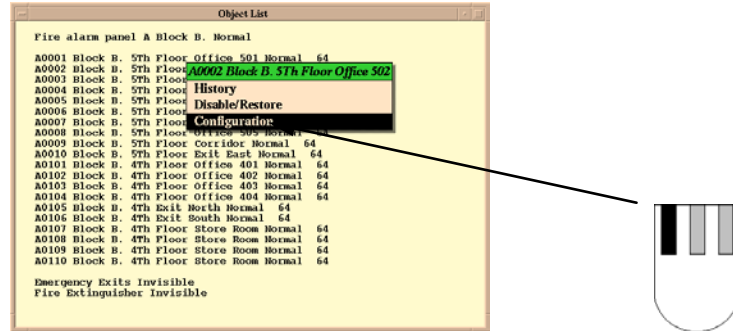

- When all detectors that are to be included in the new group are defined click OK to confirm the creation of the new group; Cancel cancels the creation of the detector group without saving. Exit closes the Detector group manager.

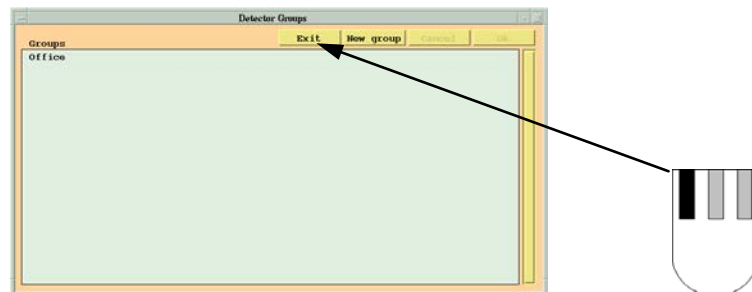
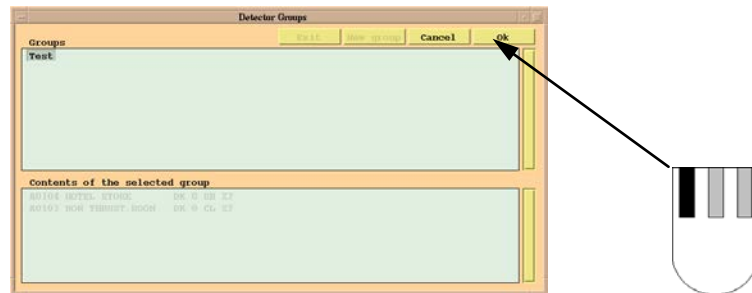

8.4.4 Deleting Groups

- Position the cursor on the Menu button, left-click-and hold down the left mouse button and choose Detector groups from the subsequent point menu.
- Select the group to be deleted.

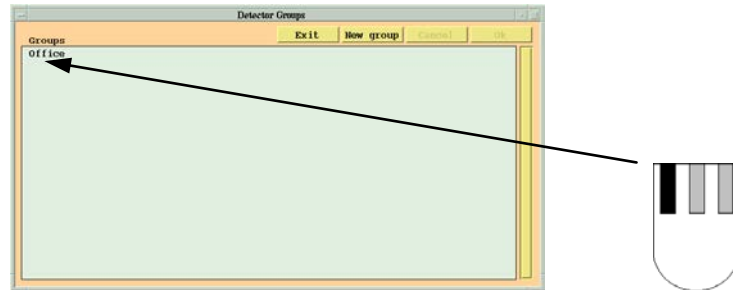

- To delete the group, first select all the detectors in the group using the left mouse button; selecting a detector makes the text of that detector become grey.

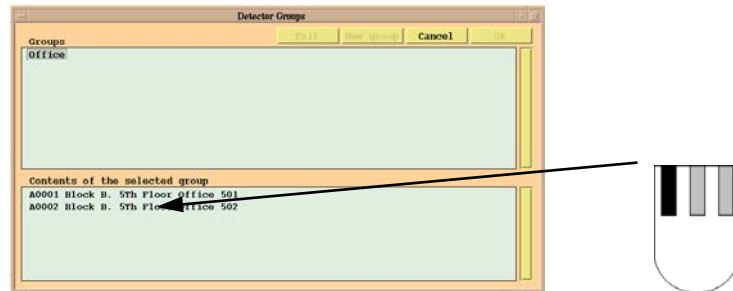

- When all the detectors have been selected click OK.



- Close the window by clicking Exit.

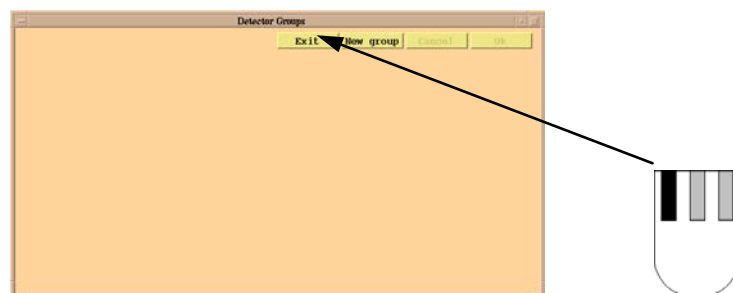

8.4.5 Disabling a Group

- To disable a group, start by clicking Disable/Enable.

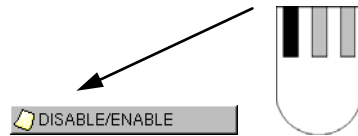

- Select the group to be disabled, using the left mouse button.



A comment can be added to the disabled group by clicking Comment, and entering a comment. Press <ENTER> to confirm.



- To define how long the group is to be disabled click the relevant button showing the required number of hours.
- Click Confirm to confirm

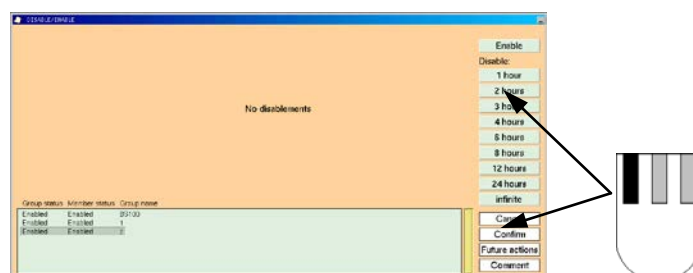

- Close Disable/Restore by minimizing it.

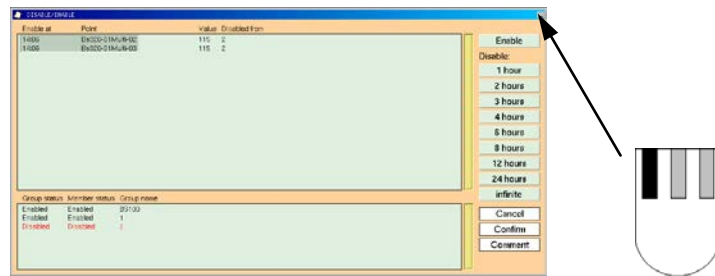

8.4.6 Enabling a Group

- To enable a group, open Disable/Enable.

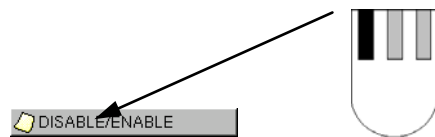

- Select the group to be enabled, using the left mouse button.

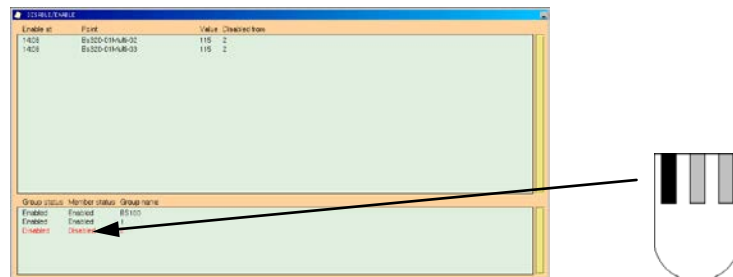

- Click Enable, click OK to confirm.

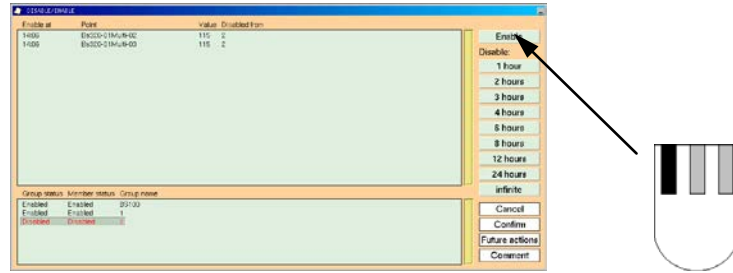

- Minimize Disable/Enable when the operation is finished.

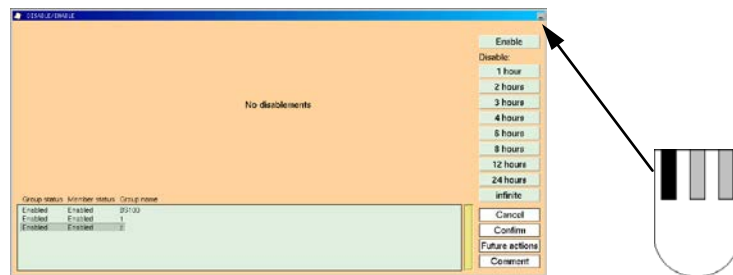

8.4.7 Time Program for Enabling/Disabling

Detectors can be disabled/enabled at pre-set times. Click the future action to open the future action dialogue.

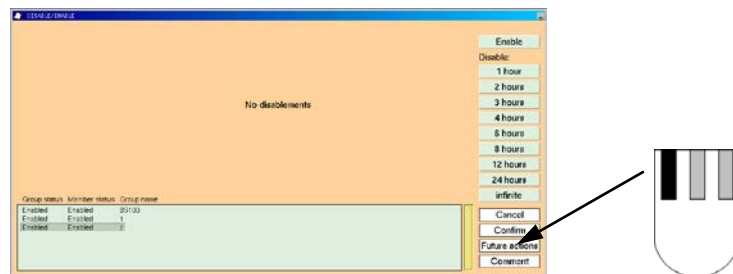

Use the buttons in the dialogue to program the required action, the fields in the dialogue take the following values:

- Out Sets the time when the group disablement should begin.
- In Sets the time when the group disablement should end.
- Days Specifies the number of days where the action should pertain.
- Date Specifies a date for the action.

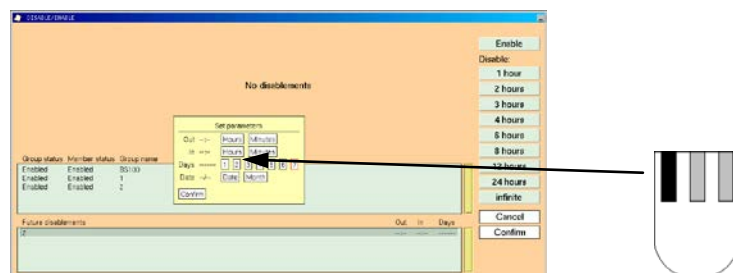

The minimum information required is the date and time for the action.

If a group is to be disabled on certain days, then the required days for disablement and restoration must be specified: 1 is Monday, 7 is Sunday.

If a group is to be disabled on a specific date, then the date must be specified instead of the day.

Note: You cannot use both days and dates to define an action.

8.5 Object browser

The Object browser shows the relation between the various units or points defined in AutoMaster; this applies especially if the unit is programmed to affect other units. The Object browser shows the name of the point and its status.

The heading should be read with focus on the relationship between the points, in order to understand which points are influenced by the selected point or which points affect the selected point.

- Activate by choosing AutoMaster 5000 > Object browser from the menu.



- Select the point using the left mouse button, and choose Select from the subsequent menu.

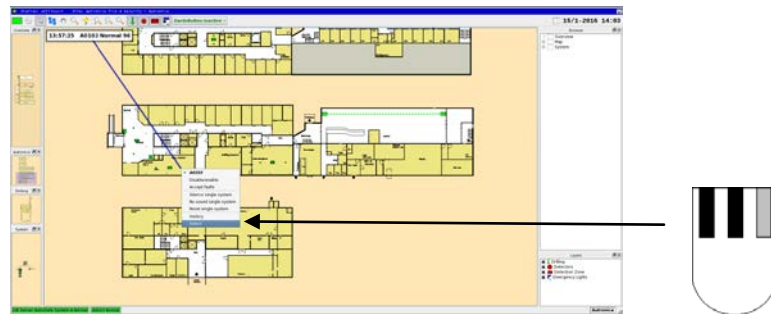

8.5.1 General

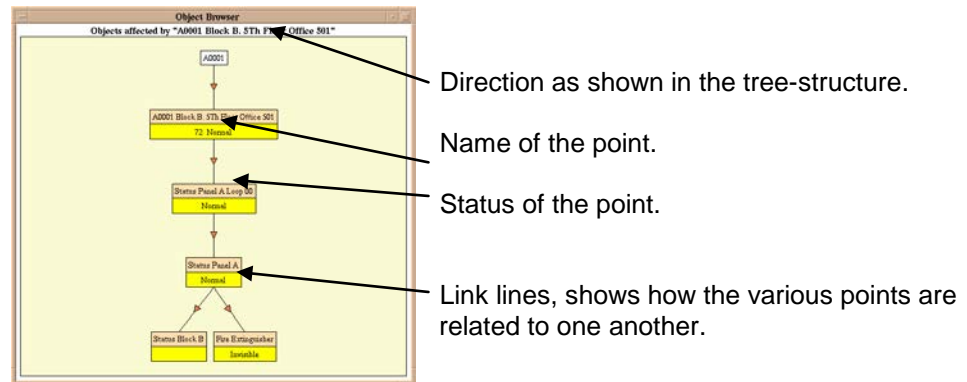

Display mode selection

By clicking on an object with the left mouse button the display mode can be changed from *Objects affected by the point* to *Objects that affect the point* and vice versa.

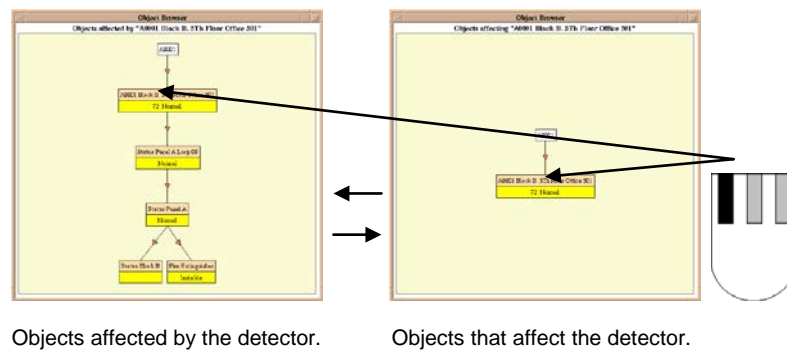

8.5.1.1 Reducing the “Tree”

The tree can be reduced by clicking on the links between the points.

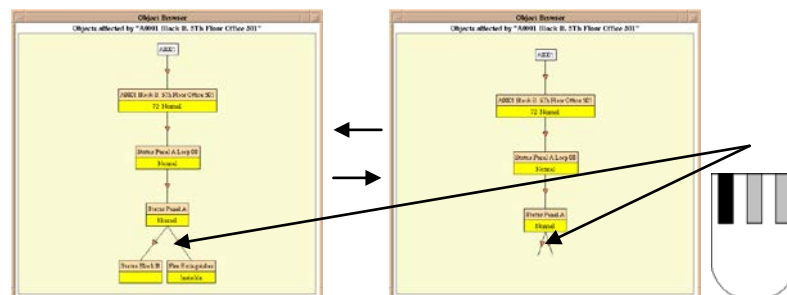

8.5.2 Example

The following set-up should be regarded as an example only.

In this example, the area coloured by detectors A0001-A0010 and A0101 to A0110 is based on detector status (Normal, Alarm, Pre-warning, Fault or Disabled). When an alarm is given, the fire-fighting equipment information layer will also appear automatically.

The points "Status Panel A Loop 00" and "Status Panel A" are created to simplify the programming.

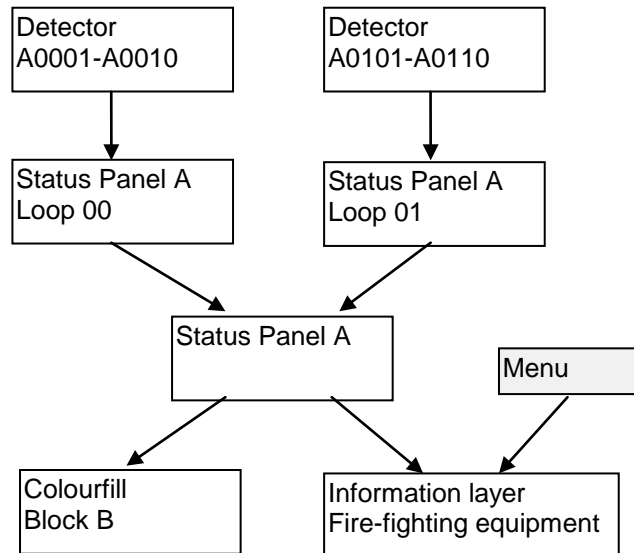

Level 1 - Detectors

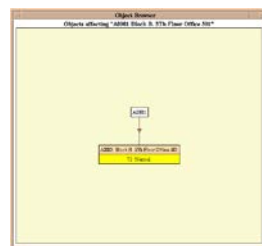

Objects affecting the detector.

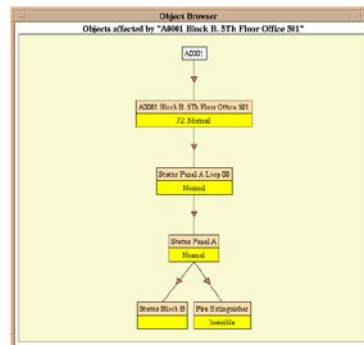

Objects affected by the detector.

Level 2 - Collect alarm from loop

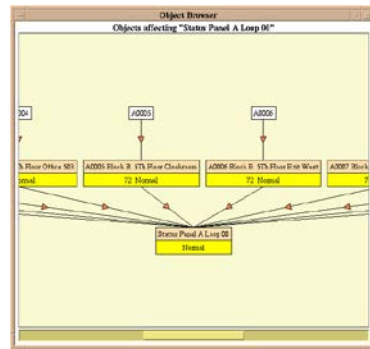

Objects affecting Status Panel A, Loop 00

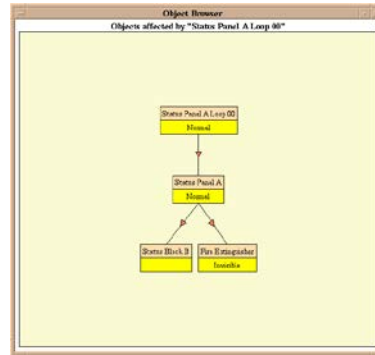

Objects affected by Status Panel A, Loop 00

Level -3 Collect alarm from control panel

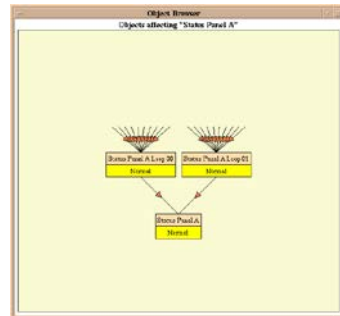

Objects affecting Status Panel A.

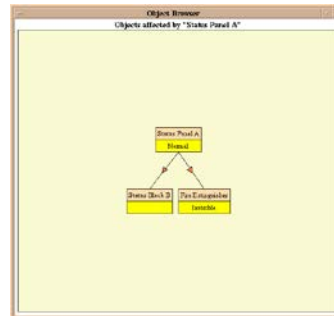

Objects affected by Status Panel A.

Level 4 - Fire extinguisher equipment

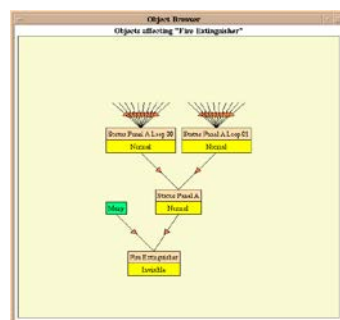

Objects affecting Fire extinguisher

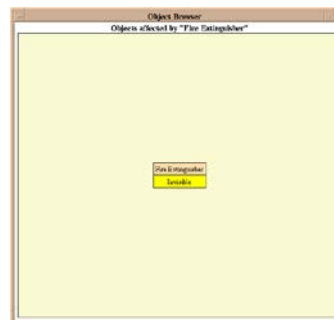

Objects affected by Fire extinguisher.

Level 4 - Status Block B (Colourfill)

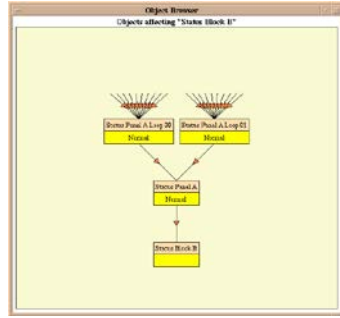

Objects affecting Status Block B

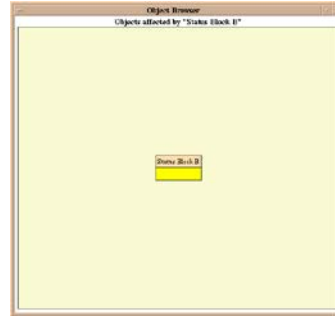

Objects affected by Status Block B...

8.6 System history

System history provides a comprehensive graphic history of all previous events in the system. A delay of up to ten minutes may occur after choosing while the system retrieves information, depending on the total number of detectors.

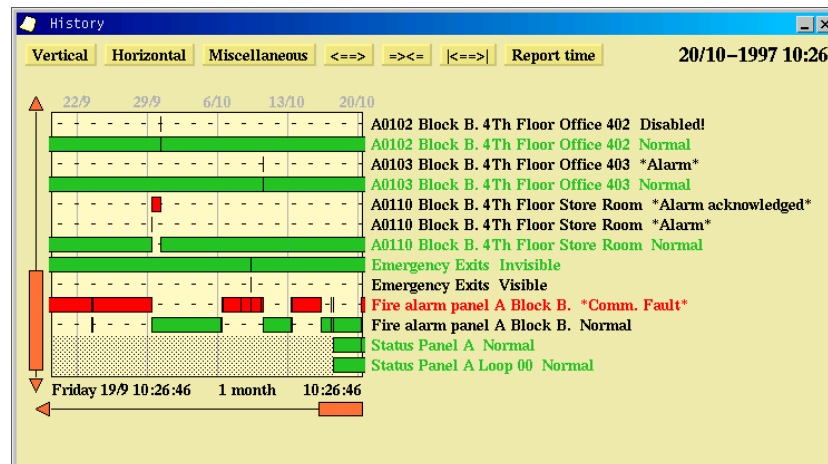

See chapter 10 for more information on how to use the history window.

8.7 Printouts

If a printer is configured and available, AutoMaster has facilities for printing in various pre-set ways; this section covers these possibilities.

For configuration information, see the Installation and Commissioning handbook.

8.7.1 Print Screen

This function generates a print-out of the whole screen.

8.7.2 Print window

This function generates a print-out of a specific window. After selecting this function click the relevant window.

8.8 Maintenance

Maintenance comprises functions such as configuration, backup procedures, clock adjustment, etc.; these are described in the following sections.

8.8.1 Show version

This function displays the current version of

- The operating system
- The windowing system
- AutoMaster
- Customer information

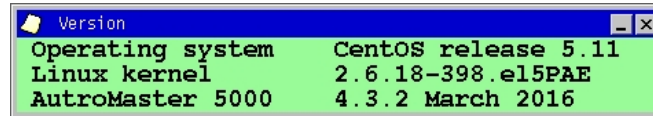

Menu options are available for the following:

- Customer information
- Register version

This window closes automatically after 10 seconds of inactivity

- To display version information for AutoMaster software, Select AutoMaster.
- To display information about the configuration, select Customer Data

Register configuration saves the current setup to disk; selecting Register Configuration, causes a dialogue to be displayed; in this dialogue, the following data-entry fields are presented:

- Enter new version number
- Version information registered by
- Comments

When the version is saved, the new version will be saved in the version log; selecting Customer data will reveal previously saved versions listed in the version log in the following format:

<Version number> <Date> <Registered by> <Comment>

8.8.2 Select Language

Select language allows the operator to choose the system language for the operating system.

- Click the required language. Click OK to confirm.

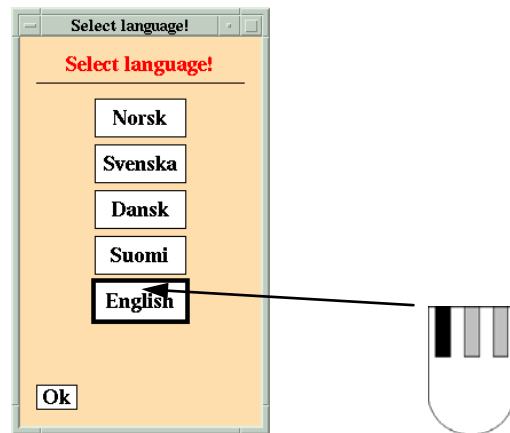

Note:

- Custom text and text statically defined in the pictures will not be translated.
- Security-clearance level 3 is required to access this function.
- Other languages may appear in AutroMaster, even if this is not illustrated in the figure above.

8.8.3 Date/Time

Date/Time allows adjustment of AutoMaster’s real-time clock.

2 terms are used: “Local time” and “UTC”. Local time relates to the machine's location; UTC (Universal Co-ordinated Time) is more commonly known as GMT.

- Select either Local time or UTC using the right mouse button, and adjust the time using the buttons in the dialogue.

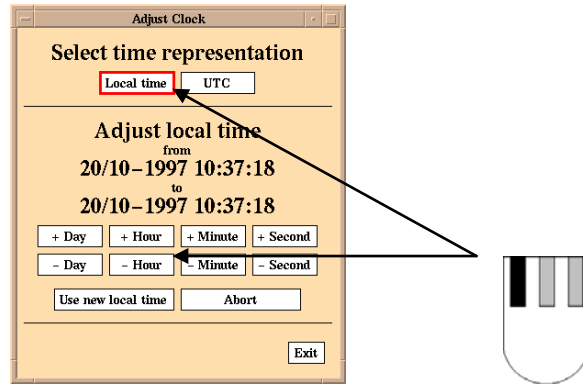

The real-time clocks in fire-alarm panels will be adjusted automatically according to the AutoMaster clock, providing this is defined. (Refer to the chapter on configuration in the Configuration Manual).

Abort is used to cancel any adjustment made to the real-time clock and to restore the original time.

- Click Exit to close the window.

8.8.4 Backup tools

This menu presents several options regarding backup and software upgrades; these are described in the following sections.

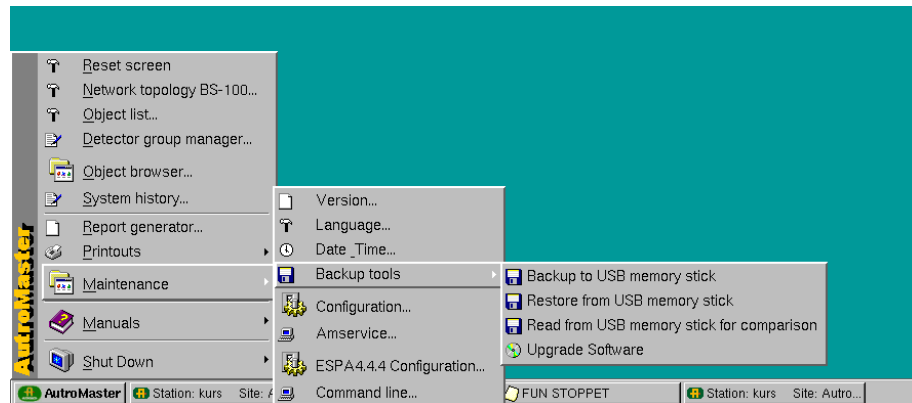

8.8.4.1 Backup to USB memory stick

A backup of all mimics, information, configuration and texts can be stored on a USB memory stick.

The backup is performed as follows:

- The presence of the memory stick is verified
- Backup is written to the memory stick

The window will close automatically when the backup is successfully completed.

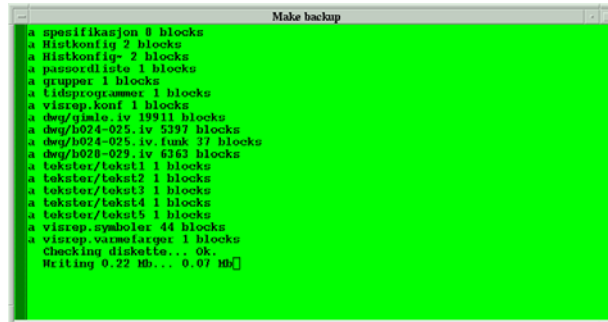

```

Make backup
a spesifikasjon 8 blocks
a histkonfig 2 blocks
a histkonfig- 2 blocks
a passordliste 1 blocks
a grupper 1 blocks
a tidsprogrammer 1 blocks
a visrep.konf 1 blocks
a dwg/gmale.iv 19911 blocks
a dwg/h024-025.iv 5397 blocks
a dwg/h024-025.iv.tank 37 blocks
a dwg/h028-029.iv 6363 blocks
a tekster/tekst1 1 blocks
a tekster/tekst2 1 blocks
a tekster/tekst3 1 blocks
a tekster/tekst4 1 blocks
a tekster/tekst5 1 blocks
a visrep.symboler 44 blocks
a visrep.varmefarver 1 blocks
Checking diskette... Ok.
Writing 0.22 Mb... 0.07 Mb

```

8.8.4.2 Restore from USB memory stick

The backup on the USB memory stick can be restored to the hard disk.

To restore the backup from the USB memory stick, insert the memory stick in the USB port.

The window will automatically close when the backup is fully restored and the machine will automatically reboot itself (after about 10 seconds).

Observe that the existing files on the harddisk will automatically be overwritten by the backup files without any warning.

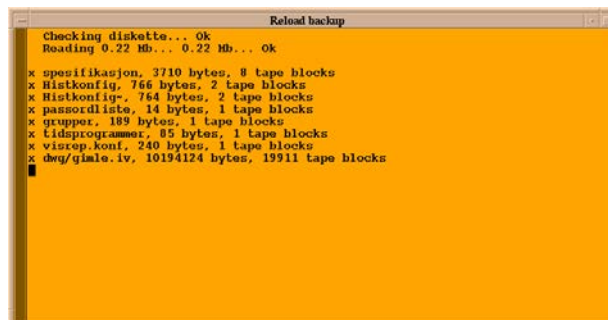

```

Reload backup
Checking diskette... Ok
Reading 0.22 Mb... 0.22 Mb... Ok

x spesifikasjon, 3710 bytes, 8 tape blocks
x histkonfig, 766 bytes, 2 tape blocks
x histkonfig-, 764 bytes, 2 tape blocks
x passordliste, 14 bytes, 1 tape blocks
x grupper, 189 bytes, 1 tape blocks
x tidsprogrammer, 85 bytes, 1 tape blocks
x visrep.konf, 240 bytes, 1 tape blocks
x dwg/gmale.iv, 10194124 bytes, 19911 tape blocks

```

8.8.4.3 Read from USB memory stick for comparison

It is possible to read the backup from the USB memory stick in order to compare it with an earlier registered version in the Report generator.

Insert the USB memory stick, select AutroMaster 5000 > Maintenance > Backup Tools > Read from USB memory stick for comparison.

8.8.4.4 Upgrade Software

Not in use anymore since CD is obsolete.
Software upgrade is performed manually in the command window.

8.8.5 Configuration

Configuration is used to configure the system. Parameters that can be configured include the number of control panels, print-outs, clock, duty control, etc. For use of this function refer to the Installation and Commissioning Manual.

Note: "Configuration" requires security level 3.

8.8.5.1 Amservice

Requires security level three. For more information about this function, refer to the Configuration handbook.

8.8.5.2 ESPA 444 Configuration

Requires security level three. For more information about this function, refer to the Configuration handbook.

8.8.6 Command line

The Command line provides access to the operative system. This requires security-clearance level 4 (Service), and should only be used by authorised personnel.

The Command line window

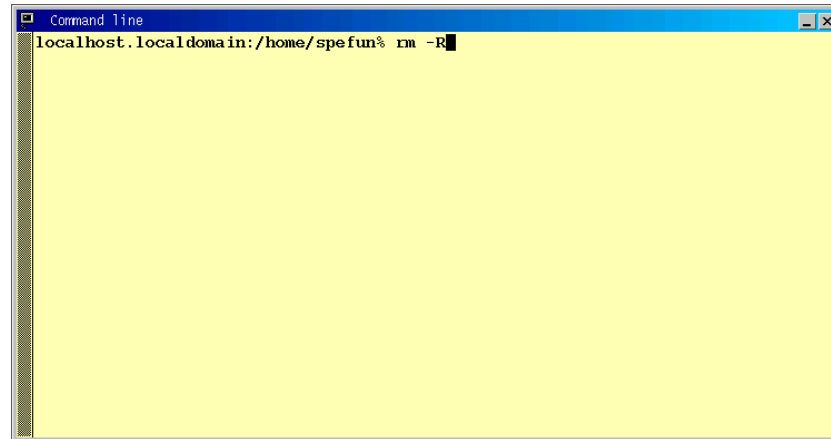

- To close the command-line window, enter the command `Exit`, press `<ENTER>` to confirm.

8.9 Help

Help contains two options: User Manual and Configuration Manual.

8.10 Shut Down

Shut Down shuts the computer down under controlled conditions. Clicking Shut Down displays two options: Yes to shut down the computer, No to cancel the operation. The machine will initiate the shut-down procedure 10 seconds after selecting AutoMaster 5000 > Shut Down > Yes.

The shut-down command can be cancelled by clicking on the count-down window before the final shut-down procedure is initiated.

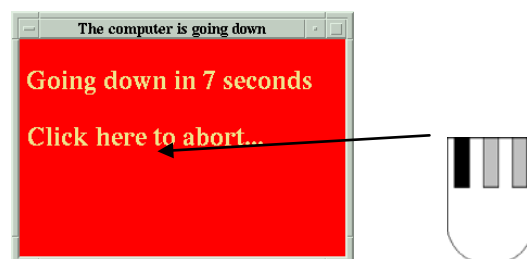

9. Report Generator

9.1 Introduction

The Report Generator allows the creation of special reports from fire-alarm system data. The following section describes these report types and operation of the Report Generator.

The Report generator allows users to preview, print and save report data on, among others, the following topics:

- History
- Analogue values
- Detector groups
- Configuration
- Versions
- Miscellaneous

Generated reports are formatted in the following way:

- Heading (e.g. AutoMaster – Autronica Fire and Security)
- Report type (e.g. System information, Version information, etc.)
- Print date (e.g. 2003/10/31)
- Page number

To access the Report generator, click AutoMaster 5000 > Report generator.

9.2 Main Page

Select AutoMaster 5000 > Report generator, the following page appears:

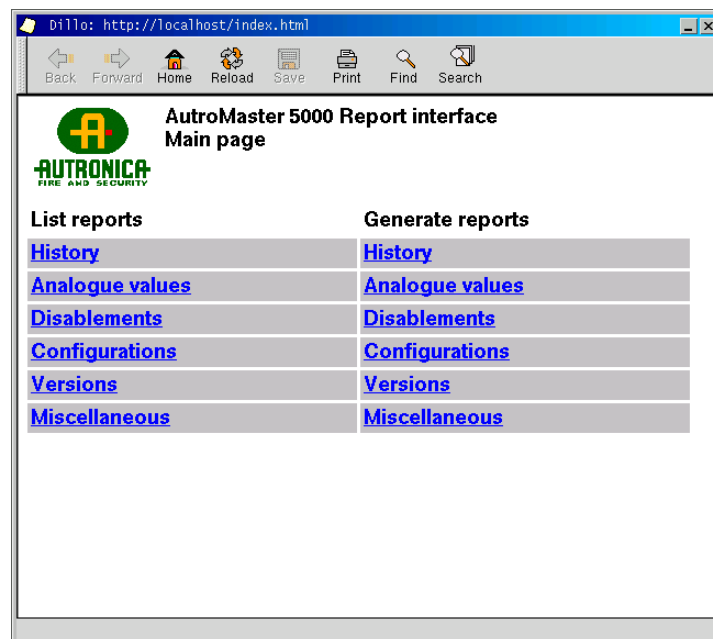

9.3 Common Functions

The Report Generator has the following buttons which function irrespective of report type:

Back: clicking this button returns to the previous page. The button is greyed-out if there is no previous page.

Forward: clicking this button returns the user to a page previously visited, after having pressed the Back button. The button is greyed-out if this option is unavailable.

Home: clicking this button returns the user to the AM5000 Report Generator Main page.

Reload: clicking this button causes the current page to refresh and update. The button is greyed-out if this option is unavailable.

Save as: clicking this button saves the report as a text or comma-separated values (csv) file. The button is greyed-out if this option is unavailable.

Print: clicking this button prints the report using the print spooler (a printer must be defined for this option to function).

Find: clicking this button finds keyword(s) in the current page.

Search: clicking this button finds keyword(s) in help documents, procedures and reports.

9.4 List Reports

The main page allows users to list and view generated reports, clicking any of the headings under List reports will result in a list of saved reports (if there are any saved reports), displayed in the following way:

Date	Recs.	Name	Comment	Display	Delete
2003-10-07 18:10	0	noname_loc.xml		Load	Delete

Date: the date that the report was created;

Records: the number of records (lines) in the given entry;

Name: the filename of the particular record;

Comment: any comment entered in the report;

Display: display the selected report,

Delete: permanently remove the selected report from the list.

9.5 Generate Reports

Clicking Generate reports takes the user to the Report Generator page, the tab History is selected by default when this page is entered, other report types can be selected by clicking on the relevant tab; the available report types are:

- History
- Analogue Values
- Detector Groups
- Configuration
- Versions
- Miscellaneous

These are described in the following sections.

9.6 History

History generates a report of the events logged in the event database; the report can be limited in terms of event type and timeframe.

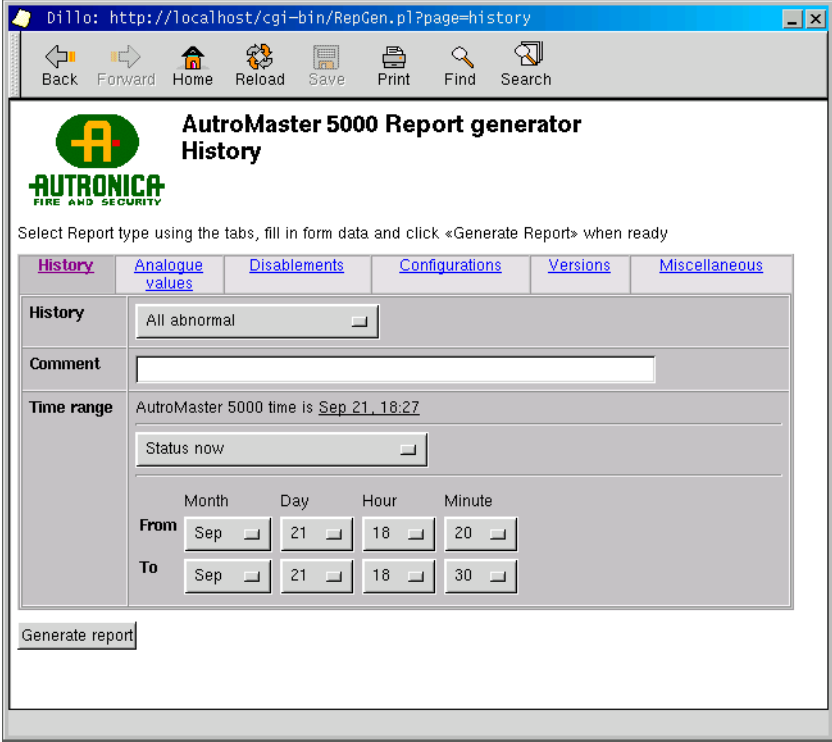

The screenshot shows a web browser window with the URL `http://localhost/cgi-bin/RepGen.pl?page=history`. The page title is "AutoMaster 5000 Report generator History". The browser's address bar and navigation buttons (Back, Forward, Home, Reload, Save, Print, Find, Search) are visible at the top. The page content includes the Autronica Fire and Security logo, a navigation menu with tabs for "History", "Analogue values", "Disabilities", "Configurations", "Versions", and "Miscellaneous", and a form for generating a report. The "History" tab is selected. The form contains a dropdown menu for "History" (set to "All abnormal"), a "Comment" text box, and a "Time range" section. The "Time range" section shows "AutoMaster 5000 time is Sep 21, 18:27" and a "Status now" dropdown. Below this, there are "From" and "To" time selection fields with dropdowns for Month, Day, Hour, and Minute. The "From" time is set to Sep 21, 18:20 and the "To" time is set to Sep 21, 18:30. A "Generate report" button is located at the bottom of the form.

9.6.1 History Type

The history report generator allows users to specify which events are to be reported; events can be delimited with the following parameters:

- All irregular; including all disablements and faults
- Event history; all events, including disablements, faults, alarms, silence, reset, change of security level
- Faults and alarms; including all faults and alarms
- Faults, including only faults in the report
- Fire alarms, including fire alarms only
- Fire alarms and prewarnings, including all fire alarms and prewarnings
- Closed doors, open doors, doors in fault
- Emergency lighting: status, fault, test log
- Other user-configured report types may exist

9.6.1.1 Time Range

Time range can be specified using the following parameters:

- Status "Now"; reports the current status
- Status at "To"; reports events from the date specified in "To"
- Status as AM History "from"; reports events from the date specified in "From"
- Status at AM history "To"; reports events specified in "To" in relation to AutoMaster time
- History through AM History "From" to "To"; reports events specified in "To" to "From" in relation to AutoMaster time
- History from "From" to "To"; reports events between the time points specified in "From" and "To"
- History last hour; reports events from the previous 60 minutes
- History last day; reports events from the previous 24 hours
- History last week; reports events from the previous 7 days
- History last month; reports events from the previous calendar month
- Last year (full); reports events from the last 12 months

From and to function in the following way; From and To can be specified in terms of drop-down lists for Month, Day, Hour and Minute.

- From: time and date for the first entry to be entered into the report, as default, this is one week prior to the present date
- To: Time and date for the last entry in the report, as default, this is the last entry in the database
- Or last: Select to include last hour, day, week or month

Note: To simplify the user-interface, it is possible to set Day to values from 1 to 31; even though certain months have less than 31 days. If a report is generated where non-existent days are included, no data is returned for those days.

Generated reports are formatted in the following way:

The screenshot shows a web browser window titled "D1110: Open doors - 2004-09-22 12:47". The browser's address bar and navigation buttons (Back, Forward, Home, Reload, Save, Print, Find, Search) are visible. The main content area displays the "AM5000 Report Open doors" with the Autronica Fire and Security logo. Below the title, the report details are shown: Date: 2004-09-22 12:47, Site name: Test AutoMaster-5000 Ver. 4.0, Comment: No. of records: 6. A table with 6 records is displayed, showing Point ID, Time, Duration, and State for each event.

Record	Point ID	Time	Duration	State
1	Bc320-Bn320/Z-Door-01	08:42:57	4 Hr 04:59 Min	Open
2	Bc320-Bn320/Z-Door-02	08:42:57	4 Hr 04:59 Min	Open
3	Bc320-Bn320/Z-Door-03	08:42:57	4 Hr 04:59 Min	Open
4	Bs320-Bn320/Z-Door-01	08:55:34	3 Hr 52:22 Min	Open
5	Bs320-Bn320/Z-Door-02	08:42:56	4 Hr 05:00 Min	Open
6	Bs320-Bn320/Z-Door-03	08:42:56	4 Hr 05:00 Min	Open

Clicking on the ID displays the defined unit in the graphical display.

9.6.2 Saving the Report

Clicking Save will save a report to disk. A dialogue appears requesting a file name (a default name will automatically be inserted by AutoMaster) and whether the data should be written as a CSV file or an XML file. Options are also available for renaming (if two reports are saved with the default name, the first report will be written over; Rename allows a user-specified name to be inserted so that the reports are not written over) and cancelling the operation.

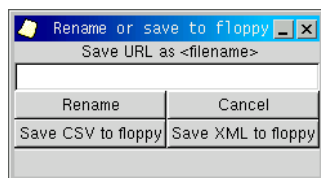

The report can be saved as an XML file or a CSV file. Saving as an XML file includes the default heading as well as report type, date and time. Saving as a CSV file causes the report to be saved in the following format with each event listed on a new line:

<Date/Time>;<Tag>;<Event>

Example:

10.01.2003 12:10:00; A0001 Office 203 2nd floor; Alarm
10.01.2003 13:08:23; A0101 Corridor 2nd floor; Disabled

9.7 Analogue Values

To generate an Analogue Values report, select AutoMaster 5000 > Report Generator, and click the Analogue Values tab in the Report Generator; this report generator creates a report of the current analogue/standard measurement values (SMV) for detectors.

The screenshot shows a web browser window with the URL `http://localhost/cgi-bin/RepGen.pl?page=values`. The page content includes the Autronica logo and the title "AutoMaster 5000 Report generator Analogue values". Below the title, there is a navigation bar with tabs: "History", "Analogue values" (which is highlighted), "Disabling", "Configurations", "Versions", and "Miscellaneous". Underneath the tabs, there is a text instruction: "Select Report type using the tabs, fill in form data and click «Generate Report» when ready". The form contains several fields: a dropdown menu labeled "Analogue values" with the text "Analogue values between" and a small arrow icon; a "Range" section with "From" and "To" labels, each followed by three input boxes containing the numbers 0, 5, and 0; and a "Comment" text area. At the bottom of the form is a "Generate report" button.

9.7.1 Analogue Values

This drop-down menu contains the following options:

- Values between
- Values outside

Selecting these options defines whether the analogue values returned in the report should be within or outside the range specified in the range field (see below).

9.7.2 Range

The range is the limits which bound the returned values; the default inside limit for included detectors is 40, the default outside limit for included detectors is 96.

Values for range are selected from drop-down menus; whether the values refer to Inside/Outside limits is regulated by the value selected in the drop-down menu described above.

9.8 Disablements

To generate an Disablements report, select AutoMaster 5000 > Report Generator, and click the Disablements tab in the Report Generator; this option generates a report of detector group information or disabled detectors.

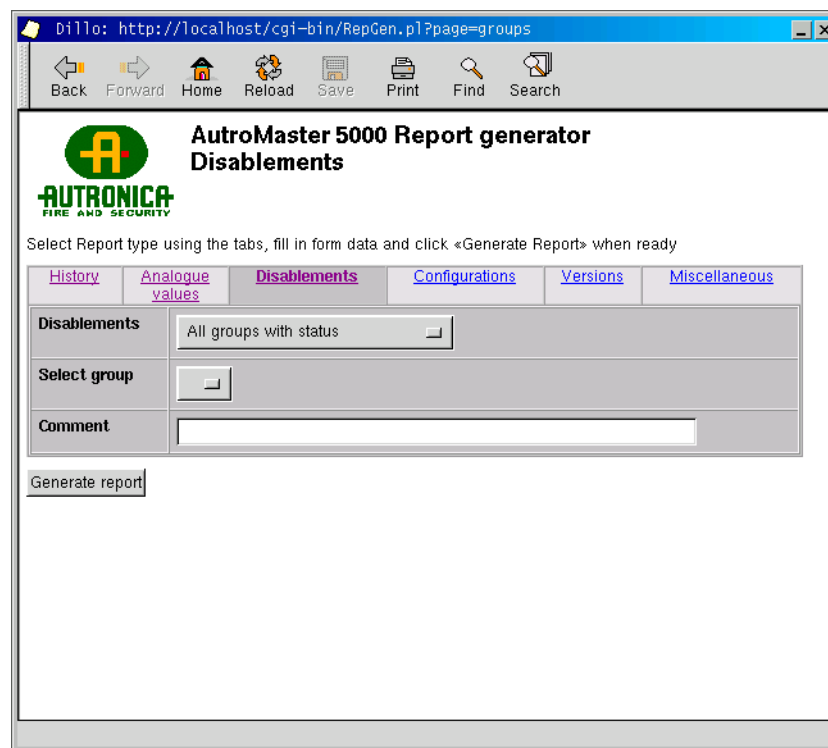

9.8.1 Disablements

The following options are available:

All groups with status; includes all detector groups in the report.
Content of a group (see below)

Current disablements; includes all currently disabled detectors and other units in the report.

9.8.2 Select Group

If Content of a group is selected, then a specific group must be selected.

This option is relevant only if Contents of a group has been selected for Disablements

The generated report will include the members and the status (disabled/enabled) of the selected group.

9.8.3 Displaying Disablements

Generating reports from predefined groups allows users to display the disabled detectors in the graphical display.

9.9 Configuration

To generate an Configuration report, select AutoMaster 5000 > Report Generator, and click the Configuration tab in the Report Generator; this option generates a comparison of a saved configuration with the active configuration.

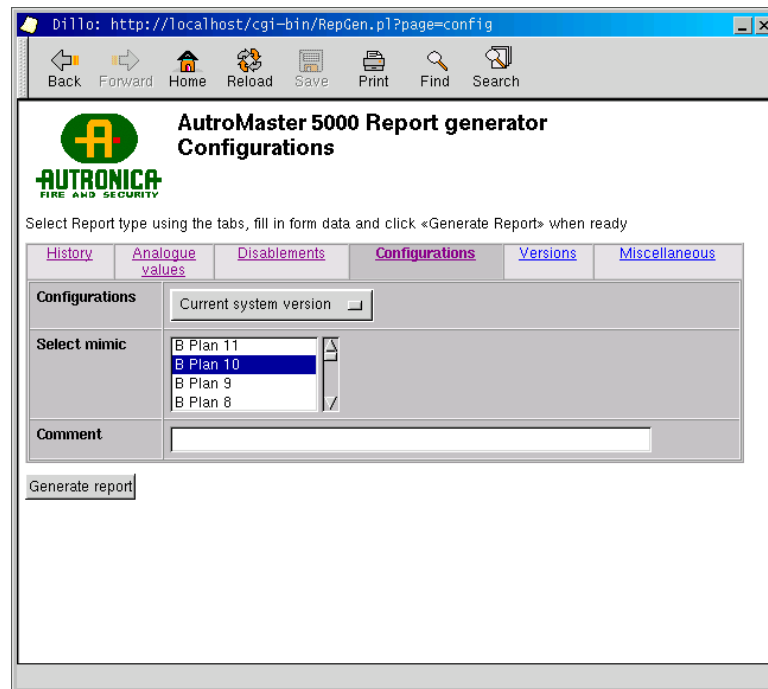

9.9.1 Configurations

The following options are available:

- Current system version.
- Defined symbols; graphic symbols as, for example, used in the system.
- Software history; historical data view of software versions
- System database; report generated from system database
- Tags in selected picture; tag names of detectors and other units which are shown in the mimic*.

*If used, must be combined with “select mimic”.

- Configuration history; historical data view of configuration

9.9.2 Select Mimic

This list selection allows users to select one from among a list of mimics specific to the system.

9.10 Version Information

To generate an Version Information, select AutoMaster 5000 > Report Generator, and click the Version Information tab in the Report Generator; this option generates a report of version information for the system and software.

The screenshot shows a web browser window with the URL `http://localhost/cgi-bin/RepGen.pl?page=version`. The page title is "AutoMaster 5000 Report generator Versions". The page features the Autronica Fire and Security logo and a navigation menu with tabs: History, Analogue values, Disablesments, Configurations, Versions (selected), and Miscellaneous. Below the tabs, there is a "Versions" section with a "Compare function definitions" button. A "Select version" section includes "From" and "To" dropdown menus, each with a "Backup" button. A "Comment" text input field is also present. A "Note!" section contains a warning message: "The reports generated here only apply to the registered configurations. A new configuration can only be registered from the maintenance menu. A backup must exist before a comparison with a backup can be made." At the bottom, there is a "Generate report" button.

9.10.1 Software Version

The following options are available:

- Compare function definitions;
 - If you save an existing configuration (for example, configuration A), and at a later stage, for example, change the control function related to a specific detector and then save the new version (for example, configuration B), you can easily compare these two versions (A and B).
- Compare other configurations
- Compare symbol definitions
 - You can find out whether new symbols have been added or not.
- Compare tag list
 - You can find out whether new tag names have been added or not.
- Compare tags in picture
 - You can find out whether new tags have been added or not to a picture.
- Compare versions
 - A summary of all changes will be presented (for example, the number of tags added, the number of symbols added, etc.).
- Compare history
 - A list of all versions that have been saved, including version, date, responsible.

9.10.2 Select Version

The following options are available:

- From/To: includes only version information between two specified versions. Versions can be specified from the drop down list boxes; these are automatically filled in with registered versions.

9.11 Miscellaneous

To generate a Miscellaneous report, select AutoMaster 5000 > Report Generator, and click the Miscellaneous tab in the Report Generator; this option generates several reports without any parameters.

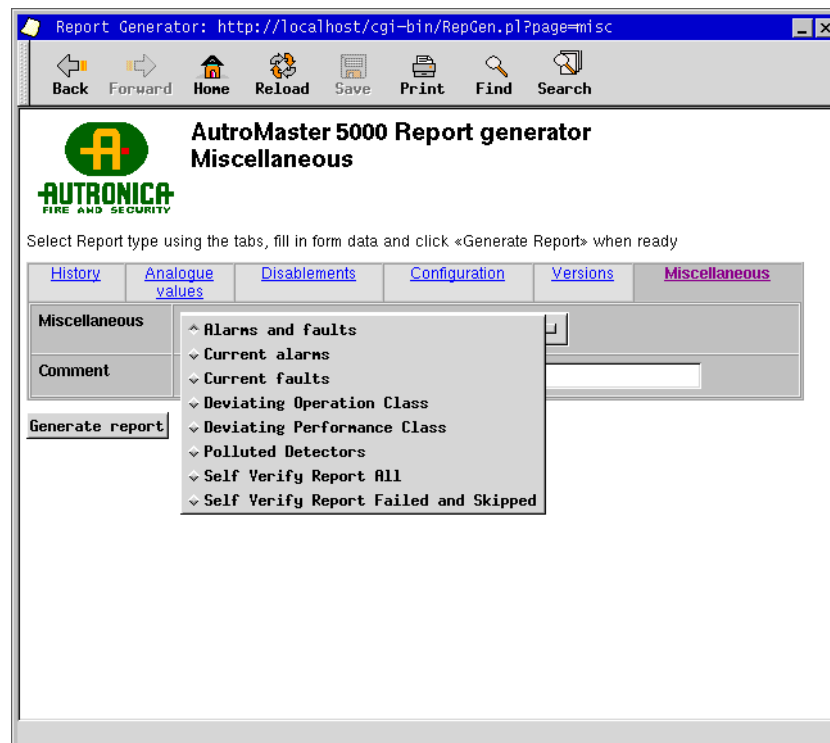

The following options are available:

- Alarms and faults; includes both of the above
- Current alarms: includes the alarm list in the report
- Current faults: includes the fault list in the report
- Deviating Operation Class: included all detectors that have been temporarily changed to another Operation Class then the configured class
- Deviating Performance Class: included all detectors that have been temporarily changed to another Performance Class then the configured class
- Polluted detectors: includes detectors with more than 100% compensation*
- SelfVerify Report All: includes complete report of all loop units*
- SelfVerify Report Failed and Skipped: includes all detectors that have failed the SelfVerify test or that are skipped due to SelfVerify functionality is not supported by the unit*

* Since the SelfVerify test is run every 24 hours. The information in the reports is from the most recent SelfVerify test, which can be up to 24 hours old. This also applies to the Polluted Detectors report.

10. History

- To view the history of a detector, first select the detector and then choose History either via the Menu button at the top of the screen or via the detector's pop-up menu.

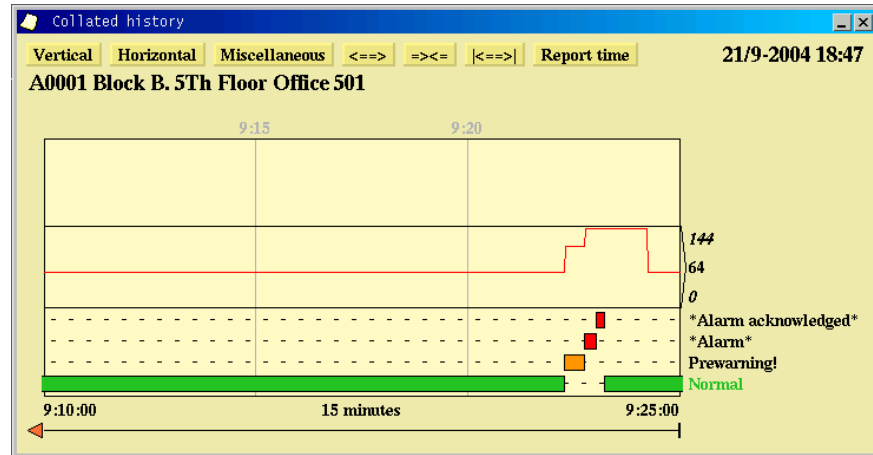

Colour codes (the default colour codes are shown – other colours may be specified)

Status	Colour code
Normal	Green
Alarm	Red
Alarm acknowledge	Red
Disabled	Grey
Prewarning	Orange
Prewarning acknowledged	Orange
Fault	Yellow
Fault acknowledged	Yellow

The screenshot shows the history of detector A0001 in connection with an alarm situation. The horizontal axis is the time scale with a resolution (in this example) of 15 minutes.

- The history window contains one curve graph and three bar graphs.
- The curve graph represents the detector's analogue value.
- The green bar shows the normal statuses of the detector.
- The red bar shows the detector's alarm statuses.

Note: the system may be configured so that normal bars are hidden, and/or unacknowledged and acknowledged events are placed on the same line.

Note: historical data on temperature readings are not stored. Only the current temperature is shown.

10.1 Functions in the History Window

10.1.1 Scrolling in the History Window

To scroll in the window either hold down the left mouse button in the horizontal scroll bar and move the mouse left or right, or hold down the middle button and move the mouse to the left or right directly in the history graphs.

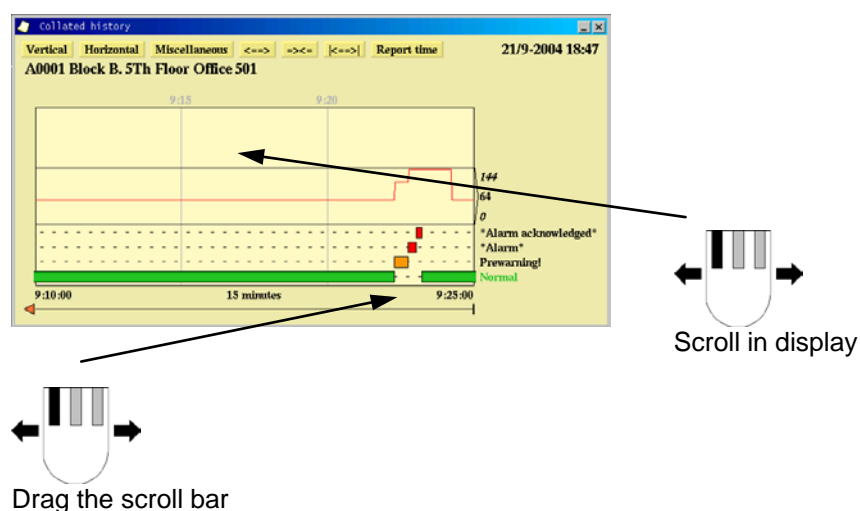

10.1.2 Dating Events

To view the exact time/date of an event click in the field for the events.

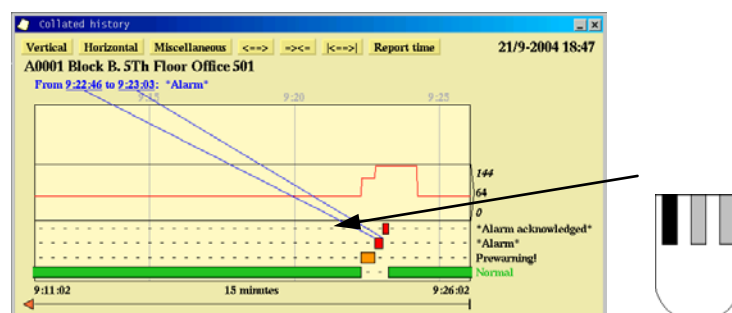

10.1.3 Reading Analogue Values

To read the analogue value of a detector simply click and hold on the curve and move the mouse in order to read the analogue value at different points in time.



10.2 The Vertical Menu

The "vertical" menu provides various options for the vertical axis in the history window.

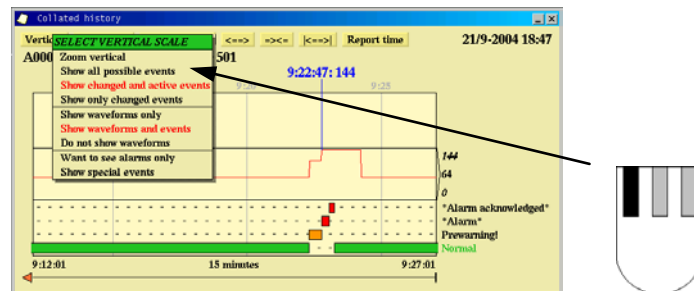

10.2.1 Zoom Vertically

SELECT VERTICAL SCALE
Zoom vertical
Show all possible events
Show changed and active events
Show only changed events
Show waveforms only
Show waveforms and events
Do not show waveforms
Want to see alarms only
Show special events

You can zoom the bars/curves vertically so that all selected detectors are displayed within the one window.

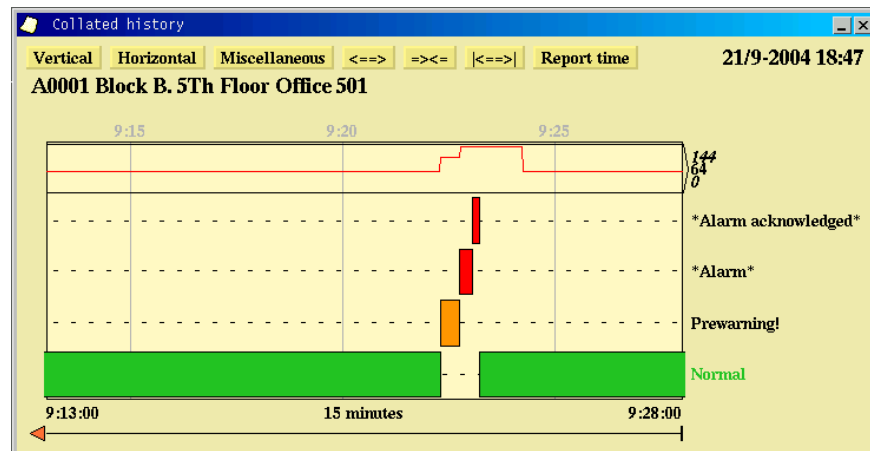

10.2.2 Show All Possible Events

SELECT VERTICAL SCALE
Zoom vertical
Show all possible events
Show changed and active events
Show only changed events
Show waveforms only
Show waveforms and events
Do not show waveforms
Want to see alarms only
Show special events

This menu allows you to view all the events for the selected detector; this also shows the periods with colour changes in the room.

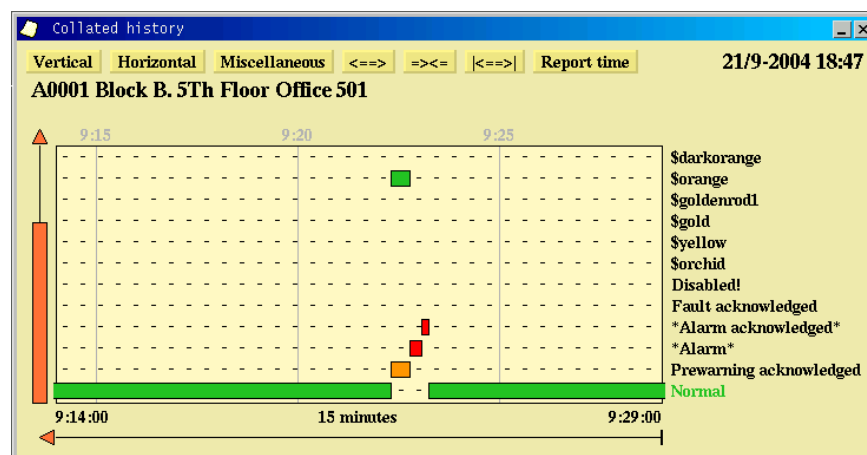

10.2.3 Show Changed and Active Events

SELECT VERTICAL SCALE
Zoom vertical
Show all possible events
Show changed and active events
Show only changed events
Show waveforms only
Show waveforms and events
Do not show waveforms
Want to see alarms only
Show special events

This menu allows you to view events that have changed in the defined period, as well as active events (the current status).

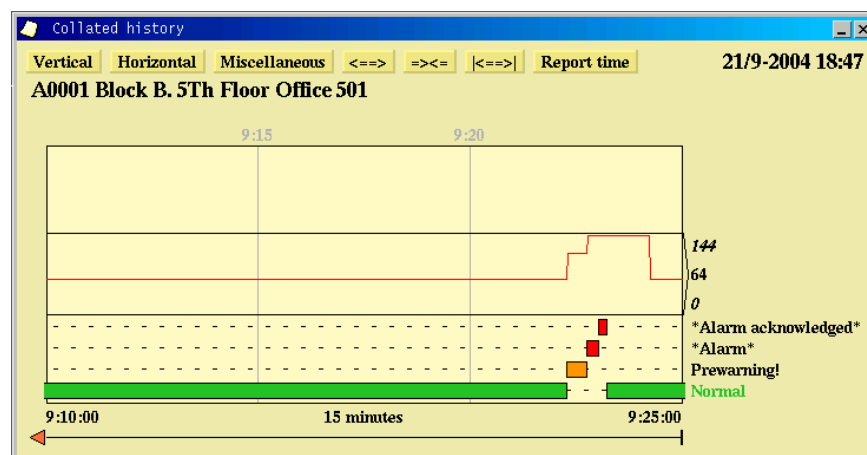

10.2.4 Show Only Changed Events

SELECT VERTICAL SCALE	
Zoom vertical	
Show all possible events	
Show changed and active events	
Show only changed events	Selected
Show waveforms only	
Show waveforms and events	
Do not show waveforms	
Want to see alarms only	
Show special events	

This menu allows you to view events that have changed in the defined period; if there are no bar graphs in the history window, this means that nothing has happened during the defined period.

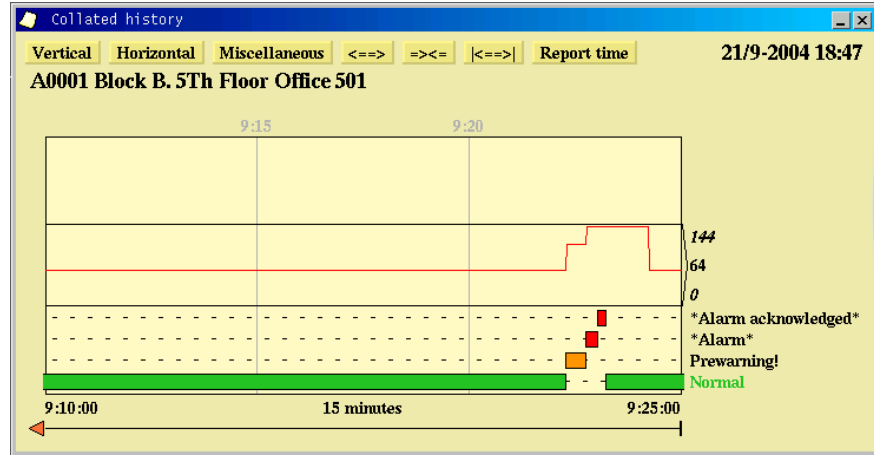

10.2.5 Show Waveforms Only

SELECT VERTICAL SCALE	
Zoom vertical	
Show all possible events	
Show changed and active events	
Show only changed events	
Show waveforms only	Selected
Show waveforms and events	
Do not show waveforms	
Want to see alarms only	
Show special events	

This menu allows you to view curves and not the bar graphs for the events.

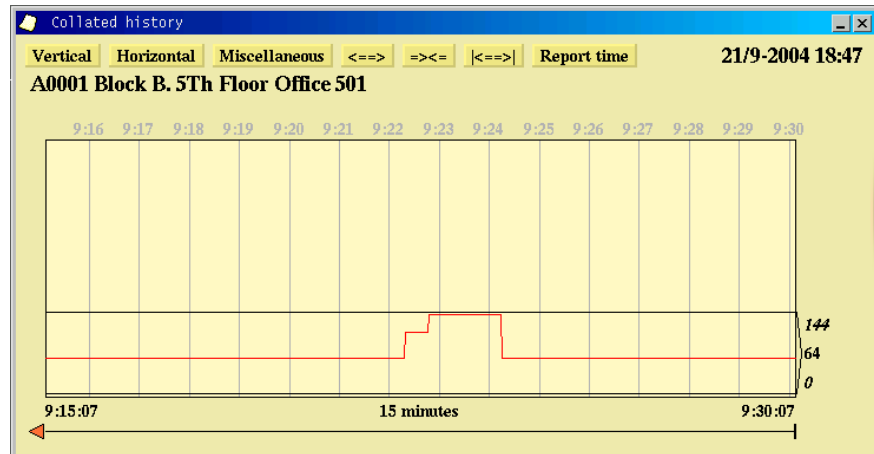

10.2.6 Show Waveforms and Events

SELECT VERTICAL SCALE
Zoom vertical
Show all possible events
Show changed and active events
Show only changed events
Show waveforms only
Show waveforms and events
Do not show waveforms
Want to see alarms only
Show special events

Shows both the curves and the event bar graphs (default).

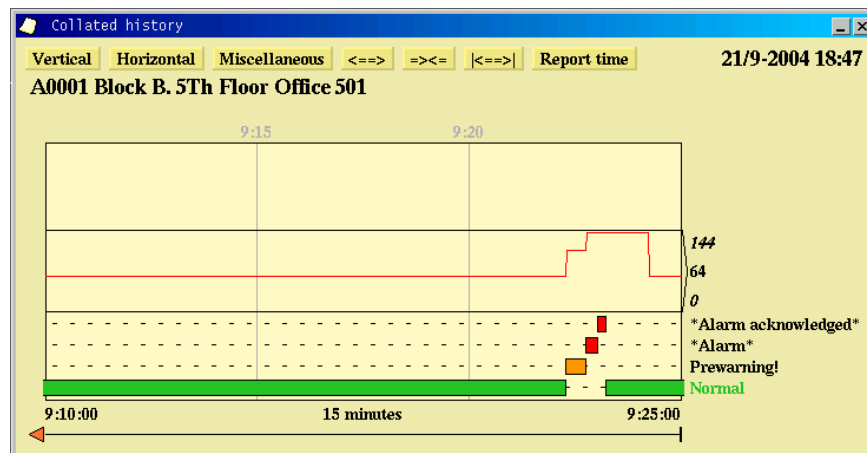

10.2.7 Do Not Show Waveforms

SELECT VERTICAL SCALE
Zoom vertical
Show all possible events
Show changed and active events
Show only changed events
Show waveforms only
Show waveforms and events
Do not show waveforms
Want to see alarms only
Show special events

Only shows the bar graphs for the events.

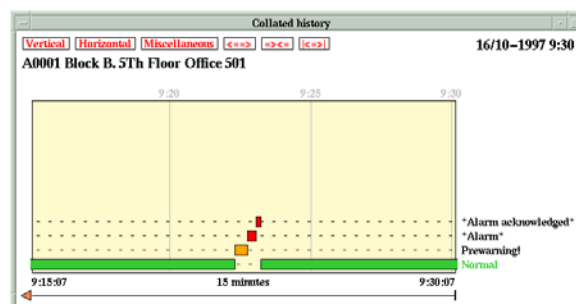

10.2.8 Want to See Alarms Only

SELECT VERTICAL SCALE
Zoom vertical
Show all possible events
Show changed and active events
Show only changed events
Show waveforms only
Show waveforms and events
Do not show waveforms
Want to see alarms only
Show special events

This menu allows you to view alarm bar graphs for the detectors. The analogue value curves may be shown if selected.

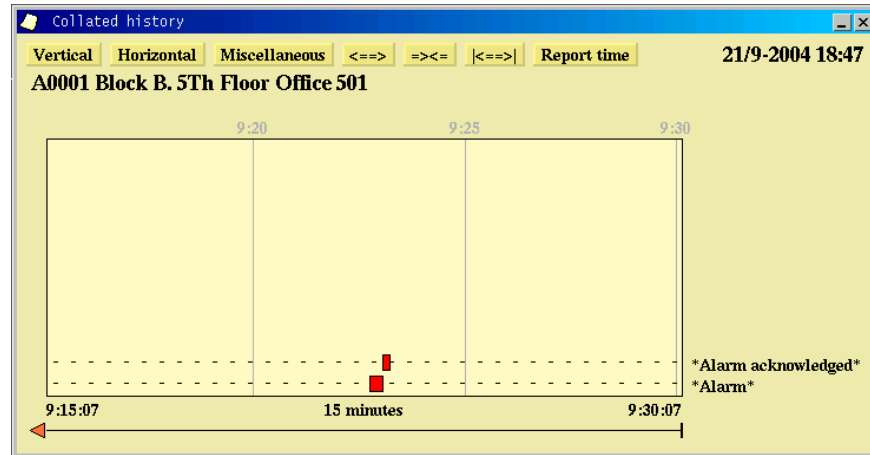

10.2.9 Show Special Events

SELECT VERTICAL SCALE
Zoom vertical
Show all possible events
Show changed and active events
Show only changed events
Show waveforms only
Show waveforms and events
Do not show waveforms
Want to see alarms only
Show special events

Show special errors displays the curves in grey when AutoMaster does not know the measured value. This function shows when the AutoMaster has been stopped; displayed as red vertical bars. This function also shows the “reasons” selected when the system has been reset.

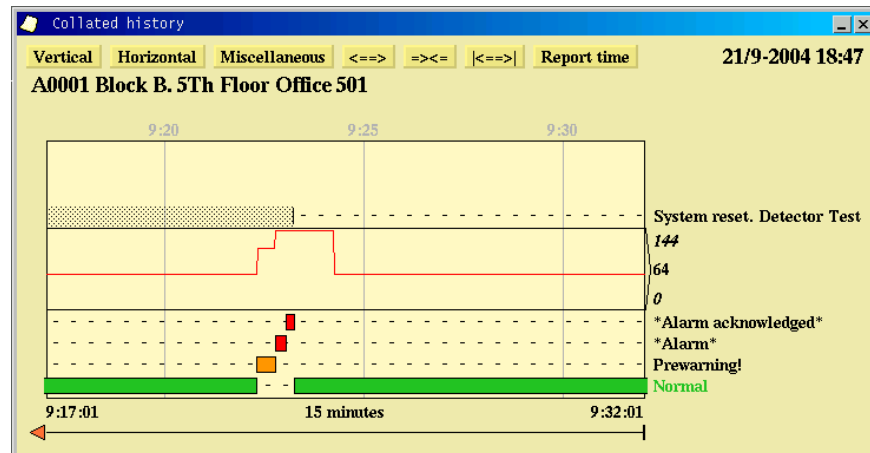

10.3 Horizontal

The "horizontal" menu enables selection of the visible time scale on the horizontal axis.

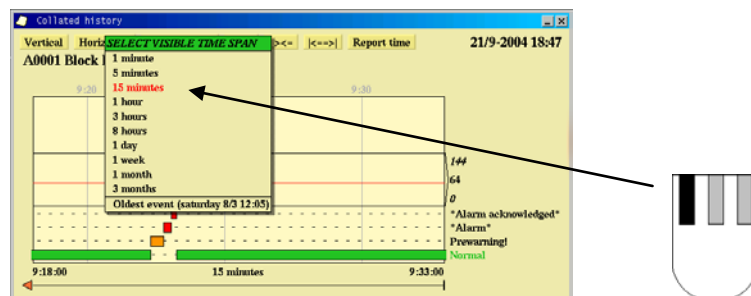

10.4 Miscellaneous

This menu contains various functions for use when studying the history log.

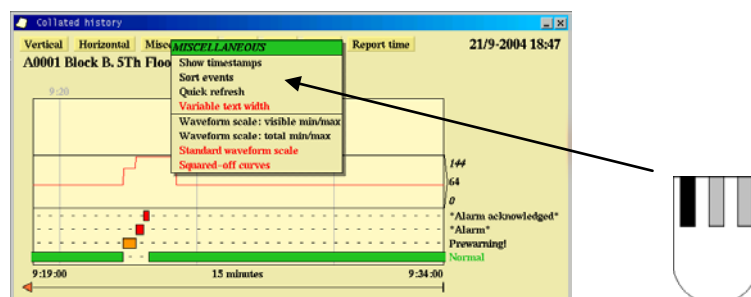

10.4.1 Show Timestamps

MISCELLANEOUS
Show timestamps
Sort events
Quick refresh
Variable text width
Waveform scale: visible min/max
Waveform scale: total min/max
Standard waveform scale
Squared-off curves

Show timestamps adds the date and time to the event bars; this provides information about when the various events occurred and how long they lasted.

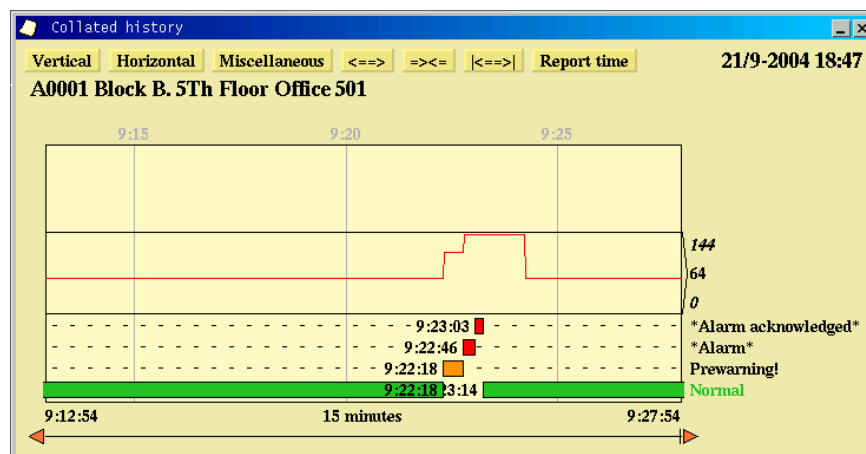

10.4.2 Sort Events

MISCELLANEOUS
Show timestamps
Sort events
Quick refresh
Variable text width
Waveform scale: visible min/max
Waveform scale: total min/max
Standard waveform scale
Squared-off curves

Sort events organises the event bars chronologically. The eldest events appear at the bottom of the window and the latest events at the top.

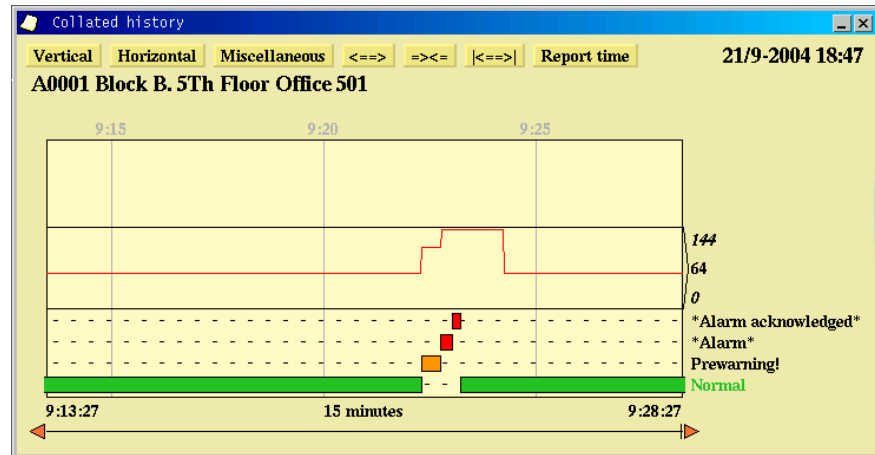

10.4.3 Quick Refresh

MISCELLANEOUS
Show timestamps
Sort events
Quick refresh
Variable text width
Waveform scale: visible min/max
Waveform scale: total min/max
Standard waveform scale
Squared-off curves

If Quick refresh is activated, AutoMaster will execute a dynamic update of the history window more regularly.

10.4.4 Variable Text Width

MISCELLANEOUS

- Show timestamps
- Sort events
- Quick refresh
- Variable text width**
- Waveform scale: visible min/max
- Waveform scale: total min/max
- Standard waveform scale
- Squared-off curves

Variable text width adjusts the history window so that the status-information text attached to the bars takes up as little space as possible.

If this is set to Fixed text width it is not possible to view the entire contents of the history window when this is re-sized.

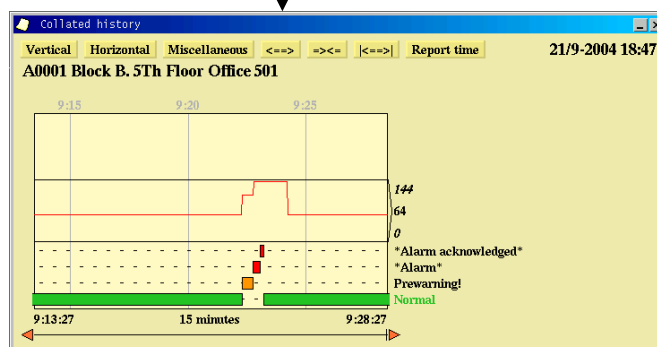
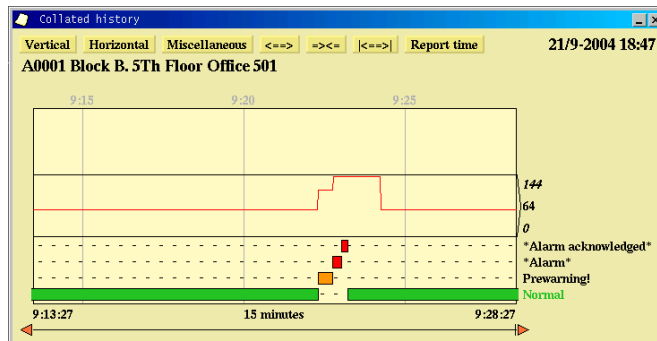

10.4.5 Waveform Scale: Visible Min/Max

MISCELLANEOUS
Show timestamps
Sort events
Quick refresh
Variable text width
Waveform scale: visible min/max
Waveform scale: total min/max
Standard waveform scale
Squared-off curves

When Waveform scale: visible min/max is chosen, the minimum analogue value for will be set to the lowest value recorded during the defined time period. The maximum value will be set to the highest value during the defined time period.

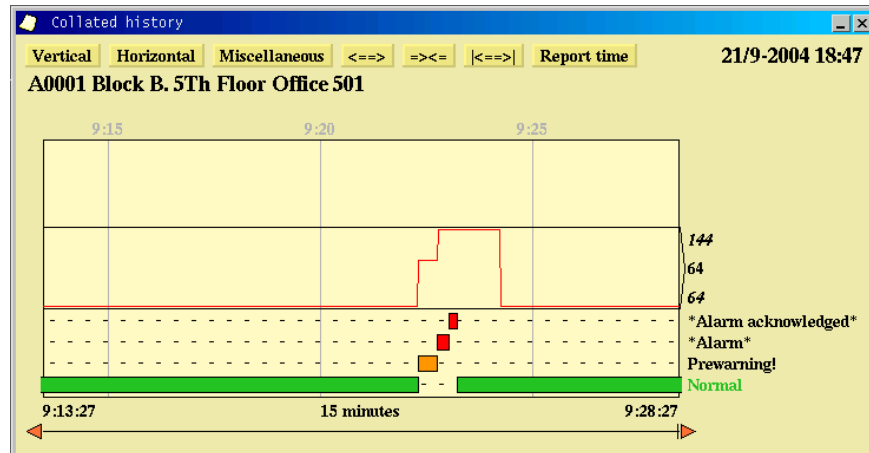

10.4.6 Waveform Scale: Total Min/Max

MISCELLANEOUS
Show timestamps
Sort events
Quick refresh
Variable text width
Waveform scale: visible min/max
Waveform scale: total min/max
Standard waveform scale
Squared-off curves

When Waveform scale: total min/max is chosen, the minimum analogue value will be defined as the lowest value reached by the detector. The maximum value is defined as the maximum level of analogue value reached by the detector.

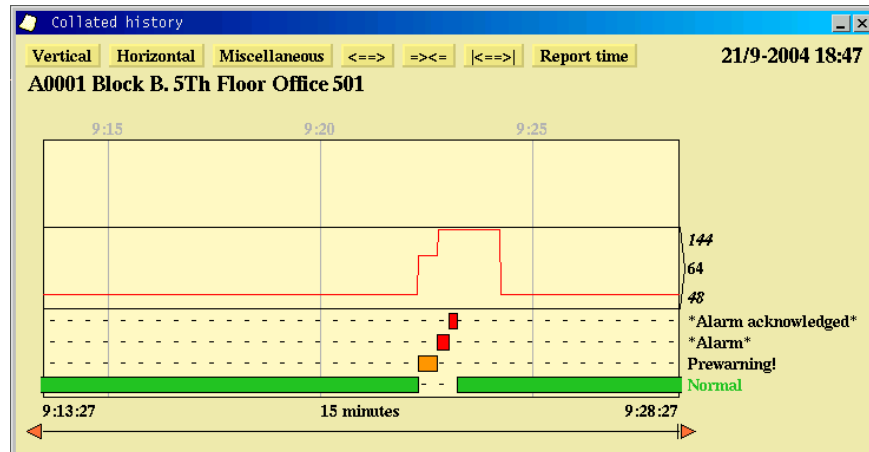

10.4.7 Standard Waveform Scale

MISCELLANEOUS
Show timestamps
Sort events
Quick refresh
Variable text width
Waveform scale: visible min/max
Waveform scale: total min/max
Standard waveform scale
Squared-off curves

This defines 0 as the lowest analogue value value and 144 as the highest.

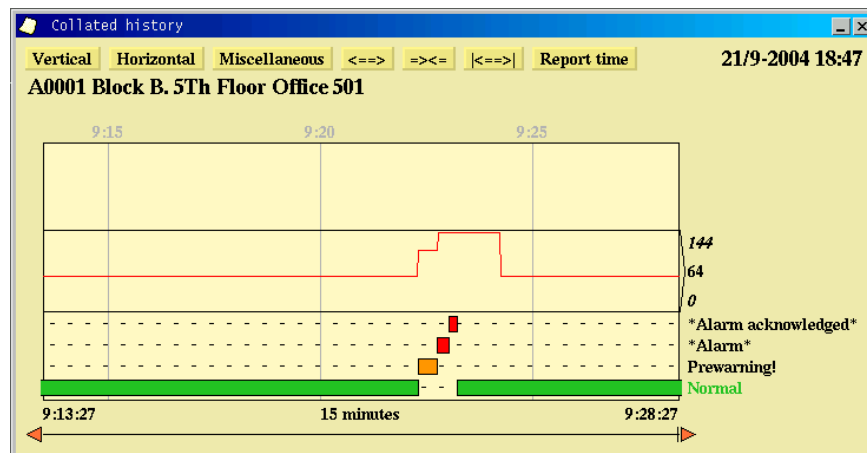

10.4.8 Squared-Off Curves

MISCELLANEOUS
Show timestamps
Sort events
Quick refresh
Variable text width
Waveform scale: visible min/max
Waveform scale: total min/max
Standard waveform scale
Squared-off curves

This option displays the graphs in stepped format instead of the normal curve format.

Normal format shows the curves by log times and will show that the analogue value has increased over time.

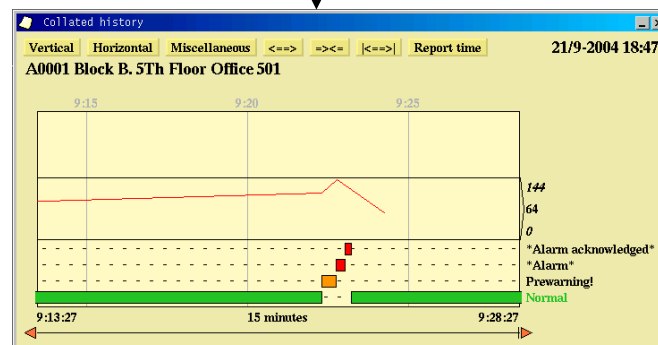
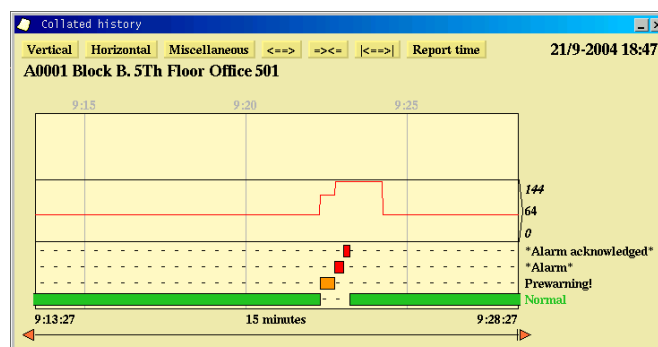

10.5 Other Buttons

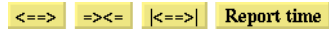

Other buttons are used to change the resolution along the time axis.

10.5.1 The <==> Button

<==> reduces the resolution of the time axis in the history window. Click on this button to view the history over a longer period.

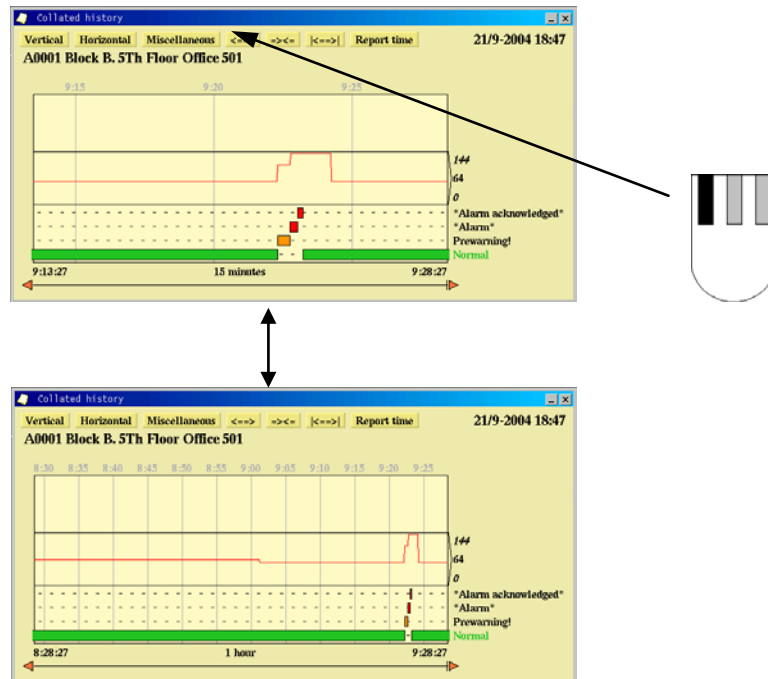

10.5.2 The =><= Button

=><= is the opposite of the <==> button. This function increases the resolution of the time scale.

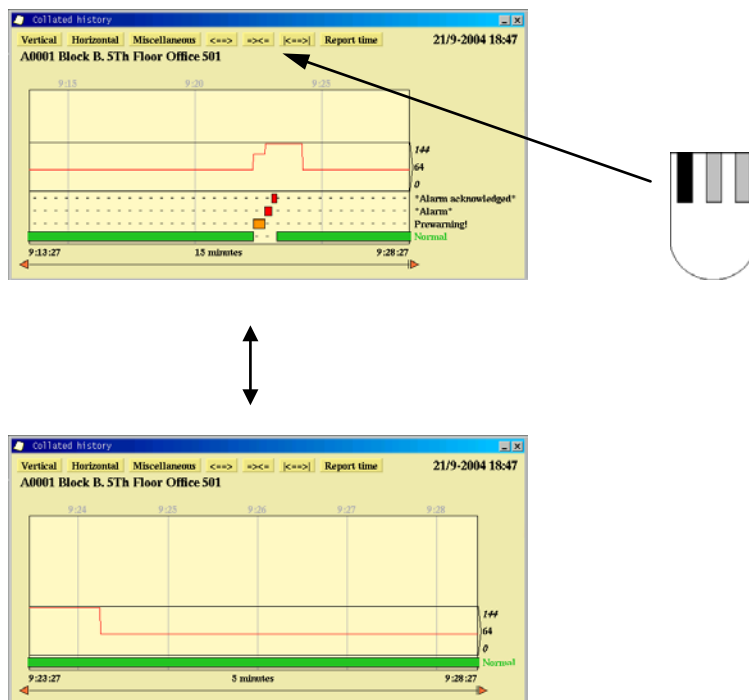

10.5.3 The |<==>| Button

This button enables zooming in the graphic window by choosing the limit values manually. After clicking |<==>|, double-click the limits to the area to enlarge.

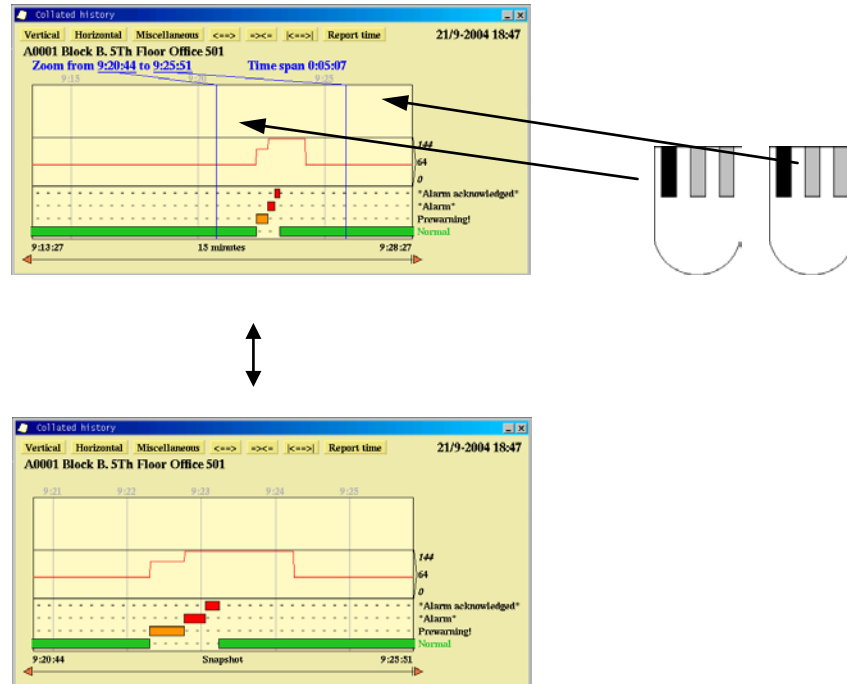

10.5.4 Report Time

Report time

This button allows export of the time scale used in the History window to the Report Generator. When the Report Generator is next started, the report time exported will be selected as the report time for History reports of the following types:

Status at AM history from
 Status at AM history to
 Status between AM history from and to

See section 9 regarding the Report generator

10.5.5 Adding Detectors to the History Window

It is possible to view more than one detector in the history window. Select in the main display those detectors you wish to view and choose History from the pop-up menu (as described previously).

This function allows viewing of the event history of several detectors simultaneously, and thus provides an overall picture of what has happened.



11. Disable/Enable Detectors

To disable a detector, select the detector in the mimic or Object List and right-click the mouse button. A pop-up menu will appear on the screen: choose Disable/Enable. This can also be achieved by clicking the Menu button after selecting the detector.

Important: Security clearance 2 (Operate) is necessary to disable/enable detectors.

Point types that can be disabled:

System	Points which can be disabled
BS100	Detectors
AutoSafe	Detectors, Detector Zones, Loop Sounders, Alarm bell outputs, Output Controls, Alarm and Fault Output, Loops

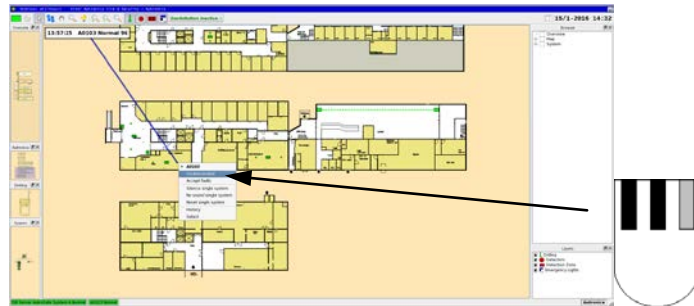

After selecting "Disable/Enable", the Disable/Enable dialogue will appear.

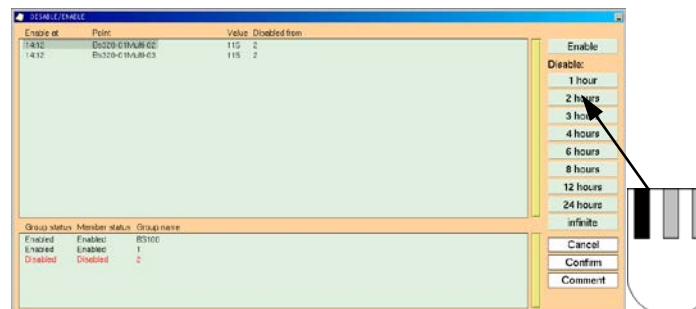

The default period for disabling a detector is 2 hours. To define another period of time, check that the detector is greyed out and then click the number of hours for which the detector should remain disabled. Click OK to confirm.

11.1 Working with Several Points

It is possible to work with several points in the disable/enable points dialogue.

Points can be selected by clicking on the line of text relating to the point. Clicking a point selects it, changing the background colour for the given line. Disablement times can be changed using the time-period buttons.

- Click OK to confirm and execute the commands. Click the minimising button to reduce the window to return the dialogue to the taskbar.

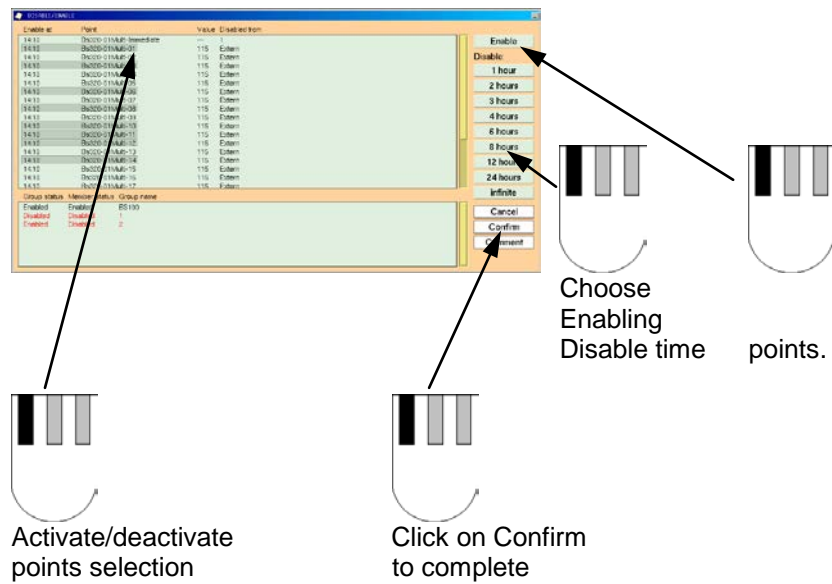

11.2 Disabled Points

- To work with points that are already disabled, click the icon for the "Disable/Enable" dialogue. Disabled detectors are dealt with exactly as described in the previous chapter.

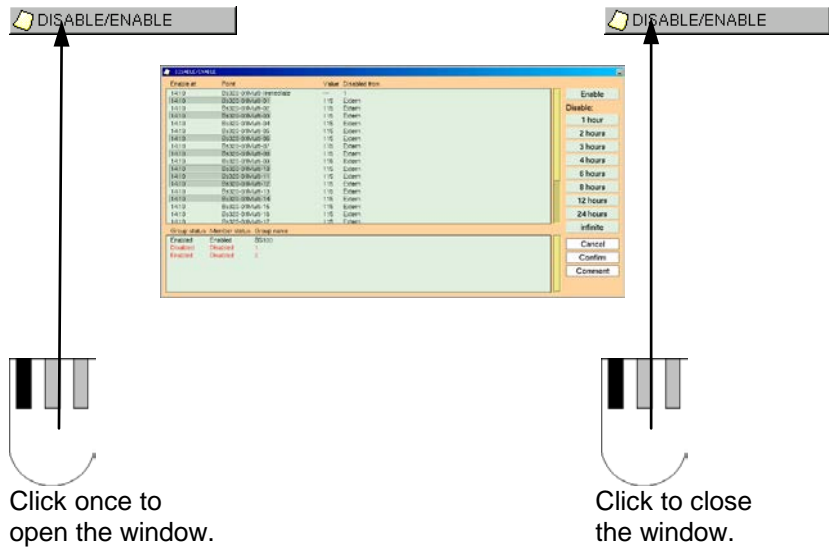

11.3 Detector Group Functionality/Overlapping Groups

AutoMaster includes support for overlapping detector groups; overlapping groups are defined as two or more groups containing the same point (detector and other points which can be enabled/disabled).

Functionality:

- A point within 2 or more detector groups cannot be enabled before the last group containing the point is enabled.
- A disabled group, which also contains a manually disabled point, enables the point when the last enable command is executed.
- Enable commands executed directly from the panel, override AutoMaster and the group is marked partly disabled.
- Disabling via panels is indicated on all AutoMasters (Disabled via BS-100/Autosafe). If a disabled point is a member of a detector group, the detector group is marked as partly disabled in the lower part of the disablement window. The point within this group indicates disablement from BS-100/Autosafe in the upper part of the disablement window.
- If the whole group is disabled and one of the detectors within that group is disabled on the panel, the detector has two disablement flags (from group and from panel) and is enabled when the last enable command is executed.
- If a detector group is completely disabled, and a manual enable of one of the members in the group, either on the panel or from AutoMaster, the detector is enabled and the group marked as partly disabled.

11.4 Replication

Replication of data ensures that disablement and detector group data does not vary according to which AutoMaster on the network is viewed. All AutoMasters connected to a network contain identical detector groups and disablement data. It is thus possible to operate the fire-alarm system irrespective of which computer is being used.

Functionality

- Detector groups are synchronized on all computers.
- Creating, modifying, erasing of detector groups on one computer is synchronized with other computers.
- Disable/Enable windows contain identical information on all computers.
- Operations performed in the Disable/Enable window on one computer causes the data to be updated on the other computers.

11.5 Future Actions

If a group is present, AutoMaster allows the scheduling of disable/enable actions for a group using the Future Actions function (this can be accessed by clicking on the Future actions button) in the Detector Group Management tool.

12. Information Layer

Information layers (if configured) comprise non-dynamic symbols organised on a separate "layer" that can be activated/deactivated as required. Such layers may cover emergency exits, fire-fighting equipment, electrical installations, etc.

12.1 Activating/Deactivating an Information Layer Using Buttons

An information layer is activated/deactivated by clicking the information layer button.

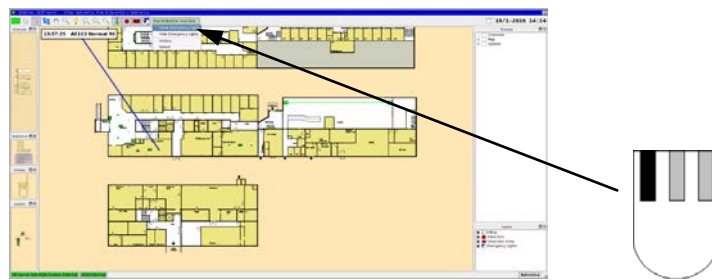

Note: the information-layer button can change from Show... to Hide... (and *vice versa*) when activated (depending on configuration).

12.2 Activating/Deactivating an Information Layer from the Object List

Information layers can be activated/deactivated from the object list by clicking and holding the respective line and selecting the required status. The statuses may vary depending on the kind of information layer being used. In this example, information layers for fire-extinguisher equipment are shown, and the current commands are Show equipment and Hide equipment.

- To view fire-extinguisher equipment choose Show equipment, to hide it, choose Hide equipment.

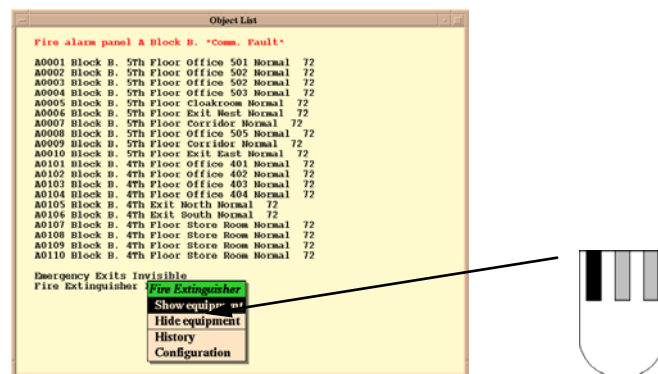

13. Operating Emergency Lighting

13.1 Gessler and Dardo Emergency Lighting

AutoMaster supports Gessler and Dardo Emergency Lighting systems. The following chapters describe the symbols and commands for both systems.

13.2 Symbols

Symbols can be located in detector mimic, information layers and/or the system overview. In the detector mimic, symbols can be activated/deactivated using switches. Note that all armatures not displaying normal status are activated in the mimic, irrespective of whether the information layer is activated or deactivated.

Example of symbols in the standard mimic

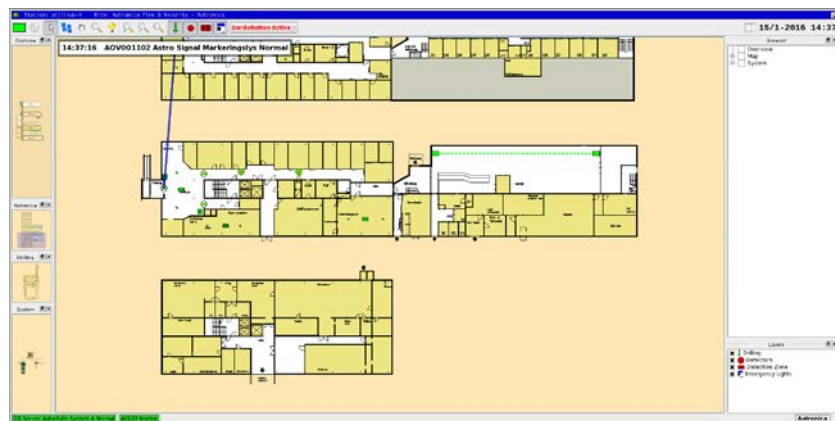

13.2.1 Gessler Emergency Light System

For Gessler you can add a picture of the front of the panel containing various information.

Example of symbols in the system overview

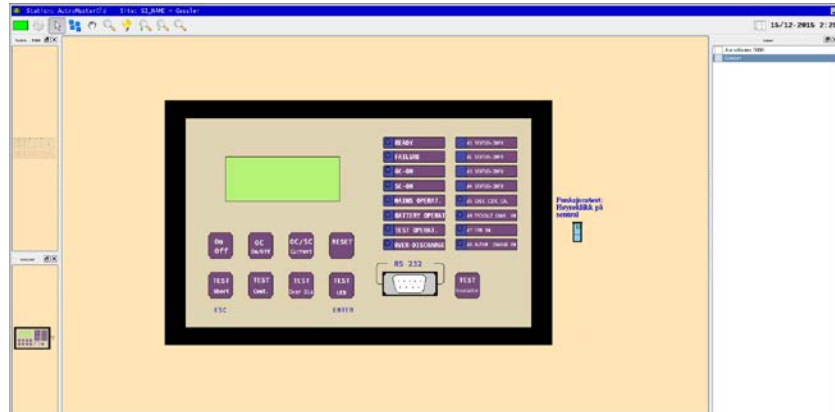

The following Gessler-specific symbols can be used:

Panel level	Line level	Armature level
Normal	Normal	Normal
Fault	Fault	Fault
Function test	No data	No data
Battery test		
No data		

13.2.2 Dardo Emergency Light System

For Dardo systems it is possible to add the system overview picture which contains AutoMaster, Dardo panels, loop and emergency lights.

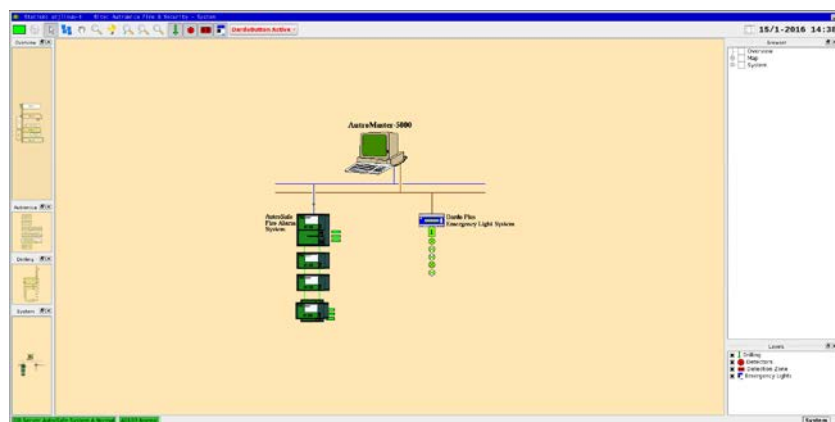

The following Dardo-specific symbols can be used:

Panel level	Line level	Armature level
Normal	Normal	Normal
Test Disabled	Fault	Battery Test Fault
Test Interrupted	Test Activated	Functionality Test Fault
Internal Battery Uncharged	Short Circuit	Battery Uncharged
Test Active	Battery Not Charged	Not Configured
Communication Fault	Communication Fault	Unknown Address
	Unknown Address	
	Disabled	

13.3 Commands

Commands that are sent to emergency light panels must be given from the mimic containing the panel symbols, and the commands must be given to each panel in turn.

13.3.1 Gessler Emergency Light System

The following commands are available:

Command	Description
Function test	Tests the functionality of the system
Battery test	Starts battery test
Cancel test	Cancel tests in progress
Reset single system	Reset the emergency light panel
Exit Lights On/Off	Turn maintained lights on/off
System On	Activates all emergency lights (if they are deactivated)
System Off	Deactivates all emergency lights
History	Open the System history window for the selected point
Configuration	Used in conjunction with History, Detector-group manager, Object list

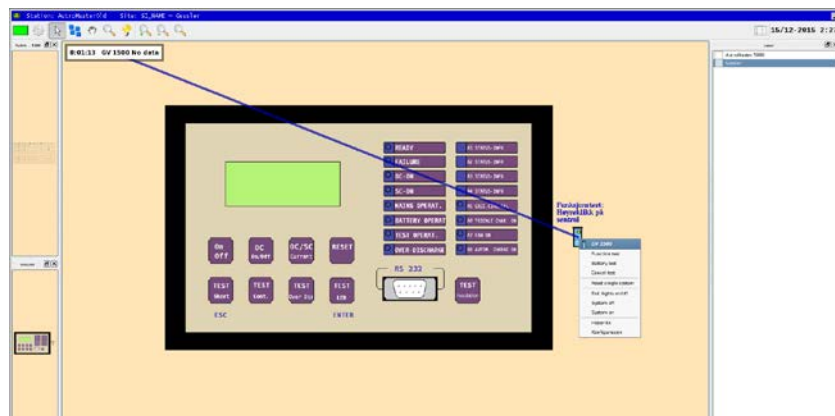

13.3.2 Dardo Emergency Light System

The following commands are available:

Command	Description
Reset	Resets disablement of emergency power
System Test	Starts system test
Battery Test (Odd Addresses)	Starts battery-discharge test of armatures with odd addresses
Battery Test (Even Addresses)	Starts battery-discharge test of armatures with even addresses
Disable Line 1	Disables emergency power to Line 1
Disable Line 2	Disables emergency power to Line 2
Disable Tests	Disables automatic tests
Enable Tests	Enables automatic tests
History	Open the System history window for the selected point
Configuration	Used in conjunction with History, Detector-group manager, Object list

Disable Line 1/2 only functions if the armatures are running on emergency power.

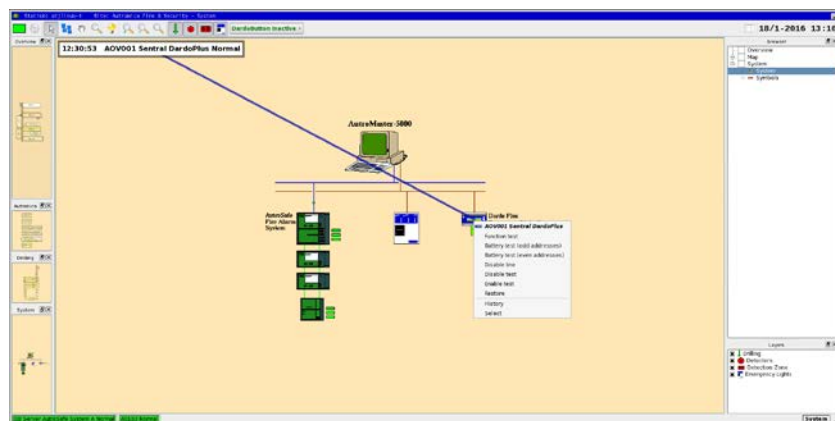
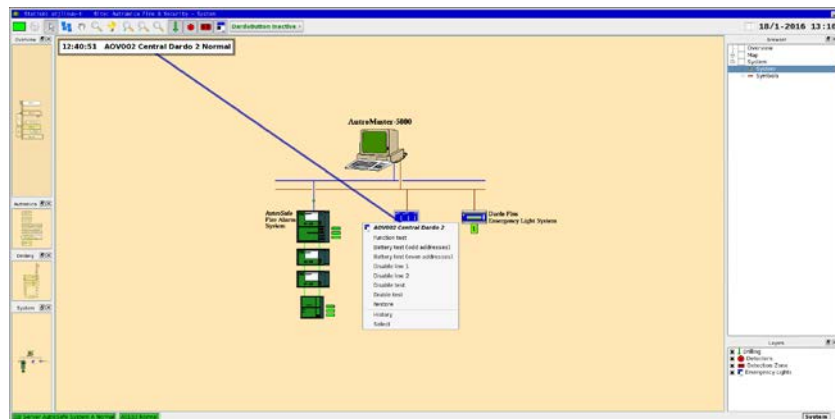

14. Watchdog

This function entails that if a fault appears on the system, a digital output is activated.

- If the watchdog detects a serious system fault, the watchdog raises an alarm (in the form of a window displaying a general system fault) directly without using AutoMaster mechanisms.

15. Time Synchronization

If computers are connected to a master clock and receive time sync information, AutoMaster is time-synchronized to the master clock.

In a network configuration, one of the AutoMasters must be defined as the NTP (Network Time Protocol) server, allowing the remaining AutoMasters to synchronize to this system.

16. Fire Doors

Fire doors can be configured in the following ways:

- Doors controlled by the system.
The status of the door's position is indicated (open, closed, opening, closing); the user controls the state of the fire doors.
- Doors not controlled by the system.
Only the status of the door's position is indicated (open, closed, opening, closing).
- Automated doors.
Doors that operate automatically in reaction to pre-configured events. The status of the door's position is indicated (open, closed, opening, closing).

The number of inputs used in the configuration determines the amount of status information that can be shown.

See section 4.4 for an overview of menu options.

17. Low-Location Lighting

The LLL symbols represent power supplies for Low-Location Lighting (LLL); LLL systems take two forms: those that can be controlled by AutoMaster and those that are fully automatic.

AutoMaster indicates the following states for LLL power supplies: On, Off, Fault and Unknown. In addition, LLL power supplies may be associated with a colourfill in the mimic, this indicates the area sustained by the given power supply.

Note that implemented redundancy (where a redundant system has been activated due to a failure in the main system) causes a different colourfill to be presented in the mimic.

For specific information on the colour system implemented an installed AutoMaster system, see the project-specific documentation provided with the system.

Clicking on an LLL point in the mimic accesses a menu with the following options:

- Disable/Enable – disable/enable the selected point
- Accept faults – accept faults from the selected point
- Turn on (on controllable systems only) – turn the selected point off
- Turn off (on controllable systems only) – turn the selected point on
- History – open the history window for the selected point
- Configuration - access configuration options for the selected point

18. Fire Patrol Supervisor

In certain applications, the Fire-patrol supervisor is implemented, this is a default program that is started when AutoMaster is started. This is a monitoring facility for the fire patrols.

- To verify that all check-points are checked according to a pre-defined plan and time schedule, security officers must turn a key at pre-defined check-points.



If a security officer is unable to check each check-point according to the time schedule, and a reason for this is not reported, a local alarm will be activated at the central guardroom (for example, the bridge on a ship).

If a security officer is unable to check each check-point according to the schedule but notifies the central guardroom, the guard in charge can click the skip button for the given check-point (or other check-points) and enter a reason for the skip in the report log. In this way, a local alarm will not be activated.

The report log contains the following information:

Type:Example:

Report ID: 256651 FPR 4B Fire Patrol DK2 MF%2

Time:13:34:33

Patrol Status:Skip

Description:Fire-patrol assisting medical officer

19. Closed-circuit Television (CCTV)

AutoMaster supports switching of Closed-circuit Television (CCTV) sources for viewing on external CCTV display systems. For details of operation of the external CCTV system, see the documentation supplied by the manufacturer of that system.

Two kinds of camera icons show fixed-position cameras and cameras whose movement can be controlled from the external CCTV system.

AutoMaster CCTV functions:

- Automatic activation of relevant cameras in the event of an alarm
- Activated cameras are indicated on screen by a flashing icon
- Manual activation of cameras

The camera functionality is governed by a list of activated cameras (listing activated cameras in order); this list provides the basis for the way in which AutoMaster interacts with the external CCTV system.

Example list:

<Camera 1>
<Camera 2>
<Camera 5>
<Camera 7>

Cameras 1, 2, 5 and 7 have been activated because detectors in their capture fields have given alarm. An operator will see the last camera added to the list displayed on the CCTV system; using the menu options that appear when a camera is clicked, AutoMaster allows the operator to assess and act upon all available information.

Clicking a camera icon reveals a menu with the following options:

- Activate – activates the selected camera manually
- Next – activates the next camera in the active camera list
- Clear active – clears the camera from the active camera list
- Clear all – clears all cameras from the active camera list
- History – opens the history window for the given camera
- Configuration – provides configuration functionality

20. Video Module

AutoMaster ISEMS features live video support. Live video from an external CCTV system can be shown on the AutoMaster (configurable).

- Left-click the check box for CCTV inside the Layer Control Pane. All CCTVs will appear in the Detail Pane.
- To view live video from a selected CCTV camera, right-click the CCTV camera, then scroll down and left-click the monitor in question (for example, Select Monitor 1).

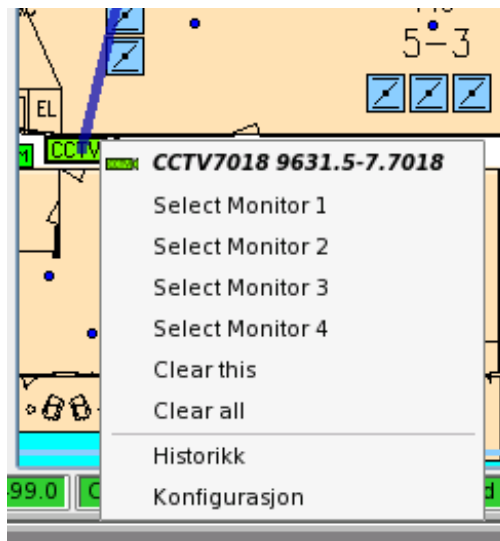

- To view live video from other monitors, enter the menu and select the monitors in question (for example, Select Monitor 2).

Live video for the selected CCTV camera will be shown on the screen.

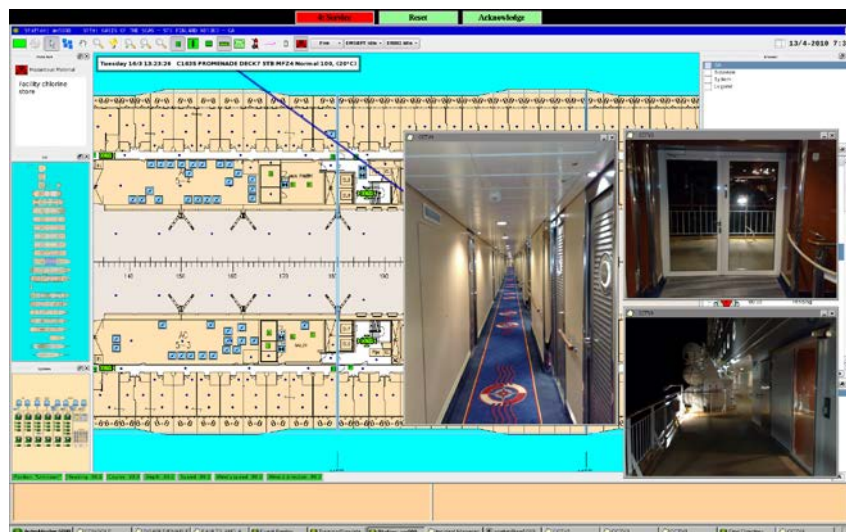

- To remove the live video for a selected CCTV camera (in this example, CCTV1), left-click the cross in the uppermost right hand corner of the video window.

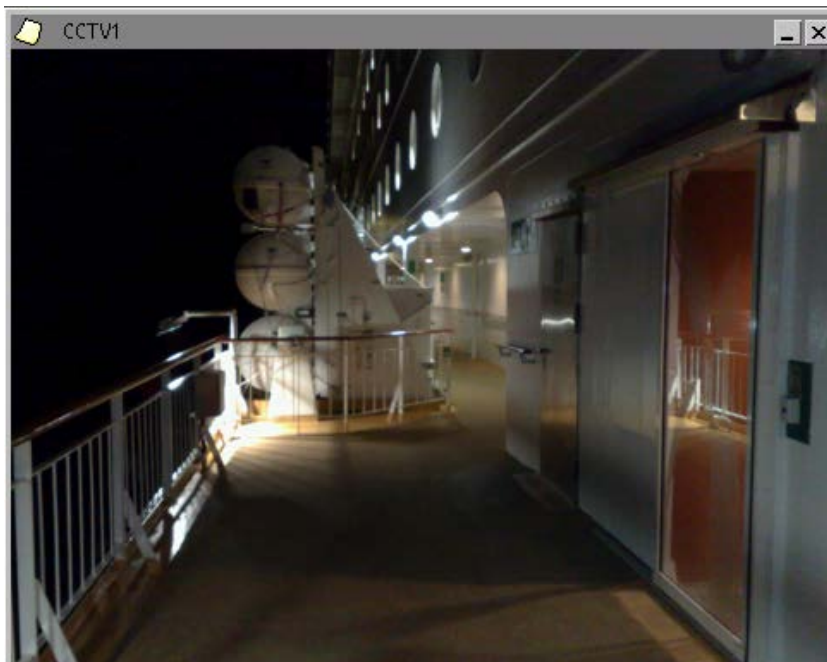

21. Programmable Logic Controllers

AutoMaster can be used as a control system for programmable logic controllers (PLCs); for user-documentation of PLC functions, see the project-specific documentation provided with the system.

22. Network Monitoring (SNMP)

Based on the the Simple Network Management Protocol (SNMP), AutoMaster provides a monitoring feature of the network and network-attached devices, including, LM switches (Lean Managed switches) and their connections. The SNMP protocol is an "Internet-standard protocol for managing devices on IP networks".

The feature ensures a constant monitoring of LM switches (Lean Managed switches) and their connections.

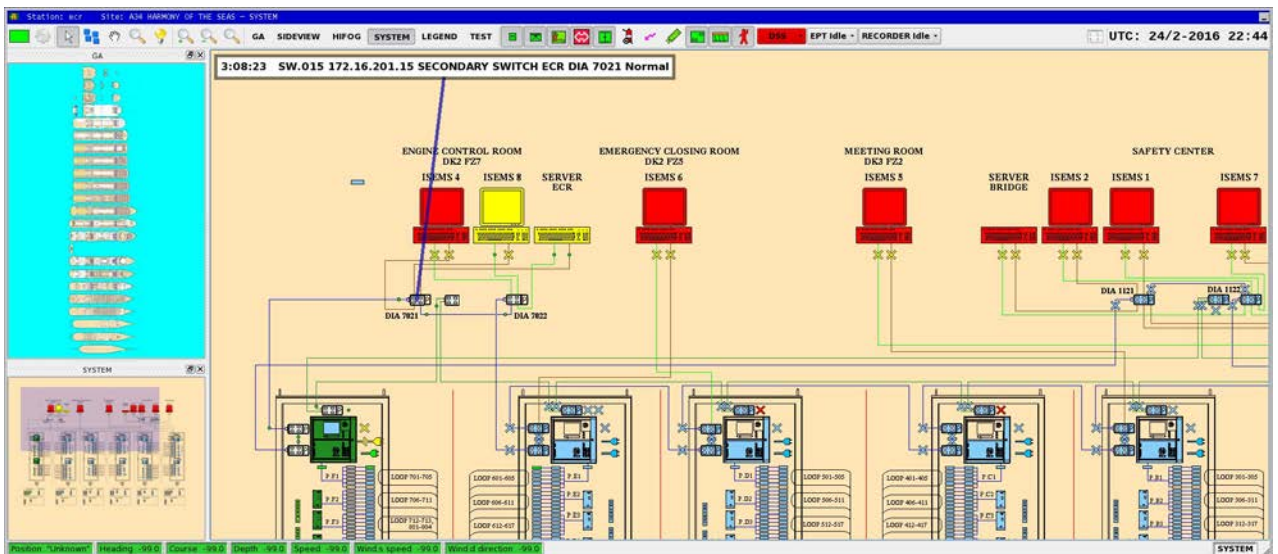

23. AutoSafe and Autoprime

AutoMaster allows the following loop units to be displayed:

- Detection zones
- Detectors
- Alarm bells
- Loop sounders
- Controls outputs
- Alarm and fault outputs, etc. (see section 4.4 for an overview of points and menu options)

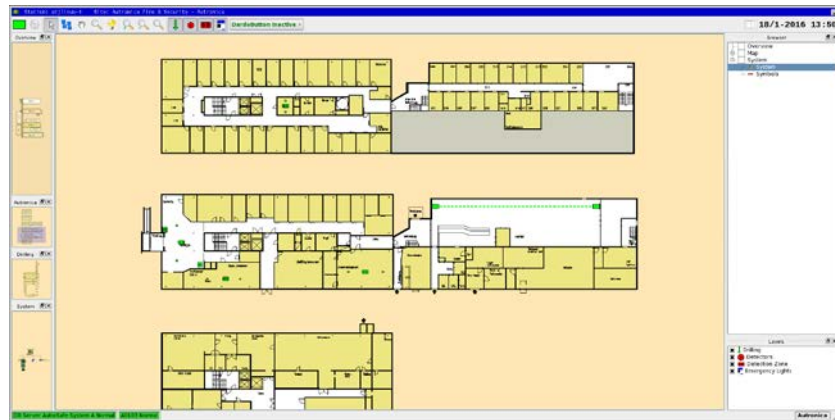

23.1.1 Detection Zones

- A detector zone can be selected by clicking on the detector zone symbol.

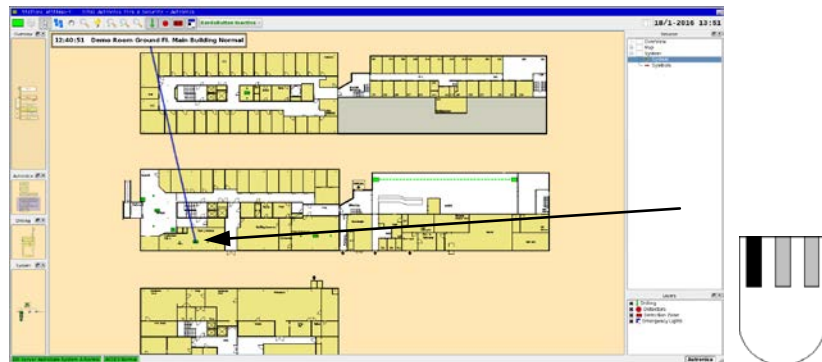

23.1.2 Selecting Detectors

- To select a detector, click it in the same way as for a detection zone.

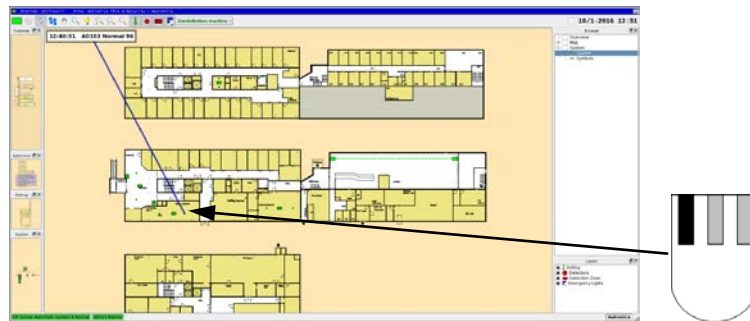

23.1.3 Alarm Mimic from the fire alarm system

The mimic for a normal situation is shown below.

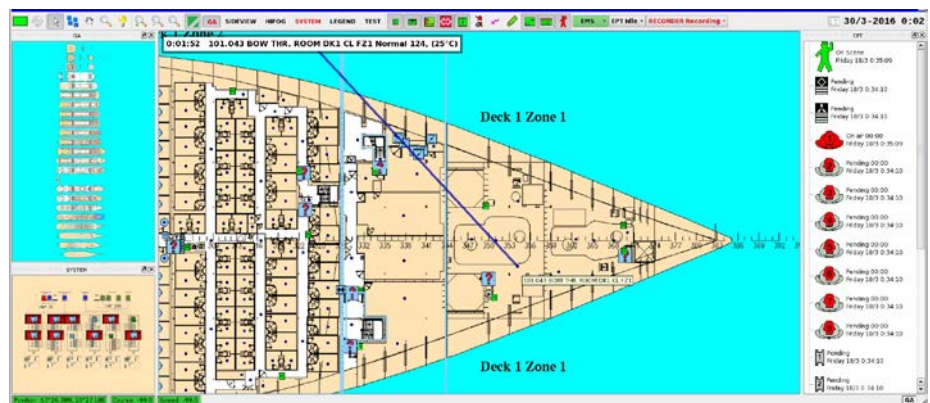

When an alarm from an fire alarm panel occurs, the screen changes so that the mimic for the detector which has given alarm is displayed. The detection zone is highlighted, and the detector which has given alarm will also be displayed, even if the detector layer is deactivated. If SMV values are configured in the mimics, AutoMaster displays colour-filled rooms/areas representing the SMV value.

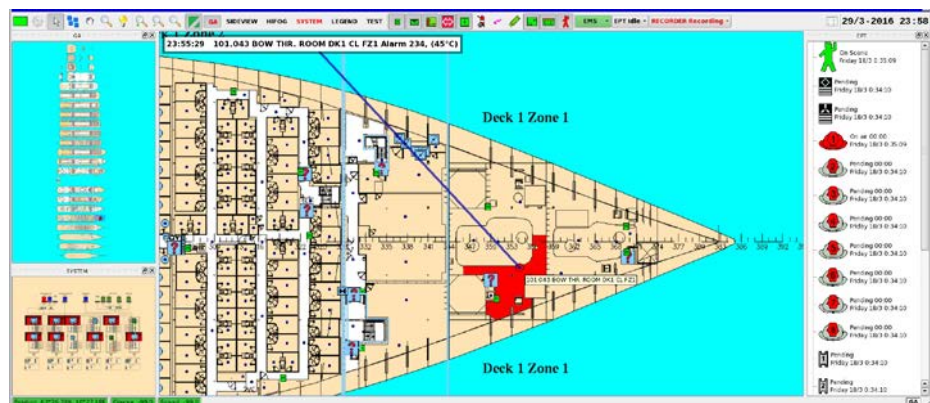

Multidetectors (smoke and heat) are used, and the heat sensor gives an alarm, purple colorfill of areas will take priority over the indication of smoke concentration (showing the areas with the hottest part of the fire).



23.2 History Functions

- To view the history of a detector zone, first select the detector zone
- Select History either via the Menu button at the top of the presentation window or by right-clicking the detector zone and choosing History from the subsequent menu.

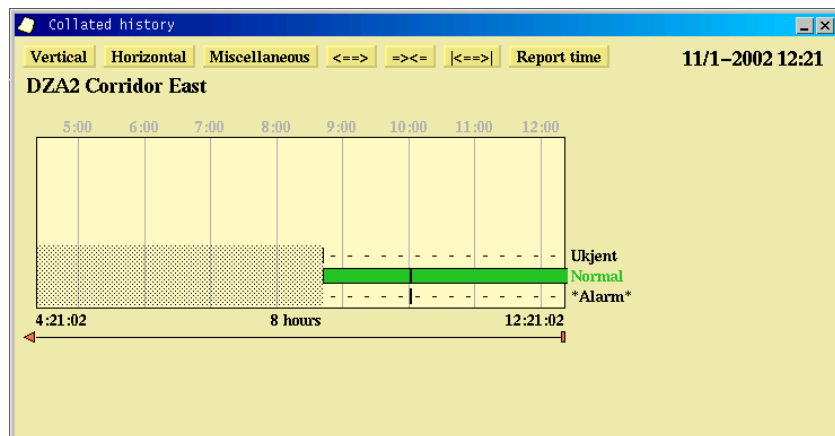

Colour codes

Status	Colour code
Normal	Green
Alarm	Red
Alarm acknowledged	Red
Alarm, small	Red
Alarm, silence	Red
Alarm, coincidence	Red
Alarm, blocked	Red
Alarm, 1. delay	Red
Alarm, prolonged delay	Red
Prewarning	Orange
Prewarning acknowledged	Orange
Fault	Yellow
Fault acknowledged	Yellow
Disabled	Grey
Unknown	Yellow

Complete history for an loop unit.

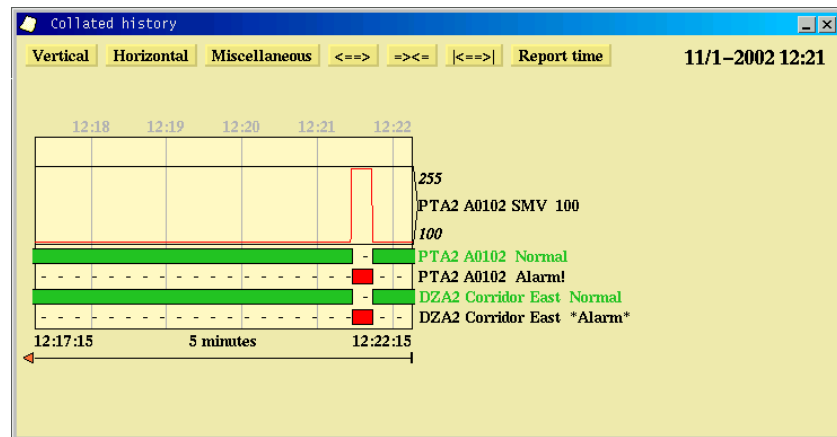

The figure shows a complete log from a point. The figure contains the detector, detection zone and the SMV value for the detector.

24. AutroSafe Dual Safety with AutroMaster as a Top-level System

24.1 AutroSafe Dual Safety Concept

AutroSafe version 4.3 and more recent versions feature the AutroSafe Dual Safety concept.

An AutroSafe system using the Dual Safety concept consists of a Primary System and a Secondary System. The purpose of the concept is to ensure that the Secondary System takes over the control of the detection loops if the Primary System is lost for any reason.

To achieve a complete graphical overview and control of the total system, AutroMaster ISEMS can be used as a top-level system, connected to both the Primary and the Secondary System via AutoCom.

For detailed information on the Dual Safety Concept, refer to AutroSafe Operator's Handbook.

24.2 Primary and Secondary System

- Primary System:
The AutroSafe system that is designed to be in Active mode during normal operation.
- Secondary System:
The AutroSafe system that is designed to be in Standby mode during normal operation.

24.3 Active and Standby Mode

- Active Mode:
The AutroSafe system is in Active Mode when it control the loops.
- Standby Mode:
The AutroSafe system is in Standby Mode when it is ready to take over the control of the loops if the system in Active Mode fails.

24.4 Indications

In the example below , the Primary system is active (the symbols for the loops are coloured green, i.e. normal operation). All system units belonging to the Primary system are tagged with P.xx, and the units belonging to the Secondary System are tagged with S.xx.

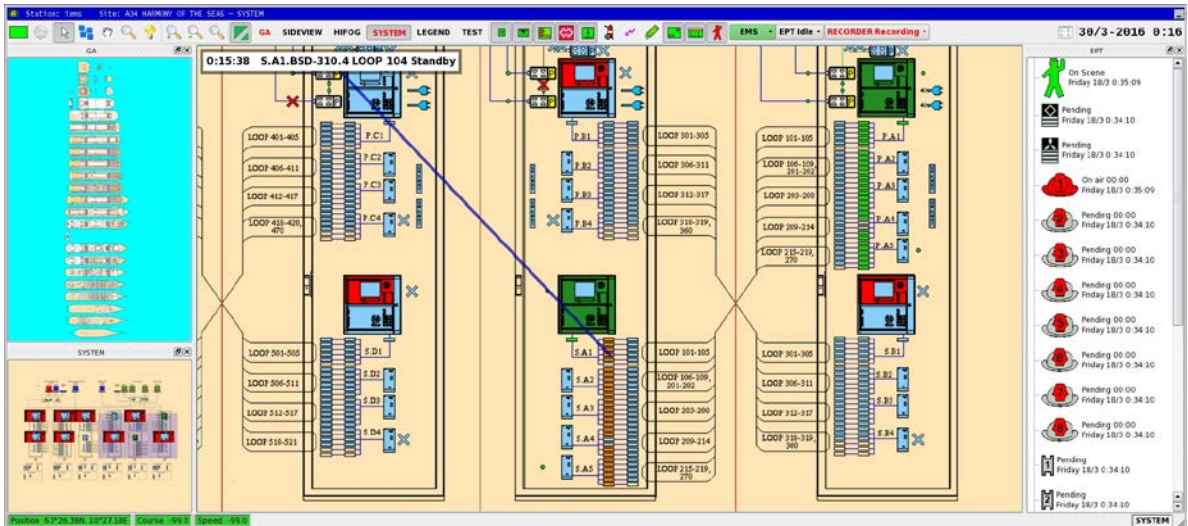

In the example below, the Secondary system is active. The symbols for the loops are coloured green and are blinking (configurable) to notify that the loops are controlled by the Secondary system.

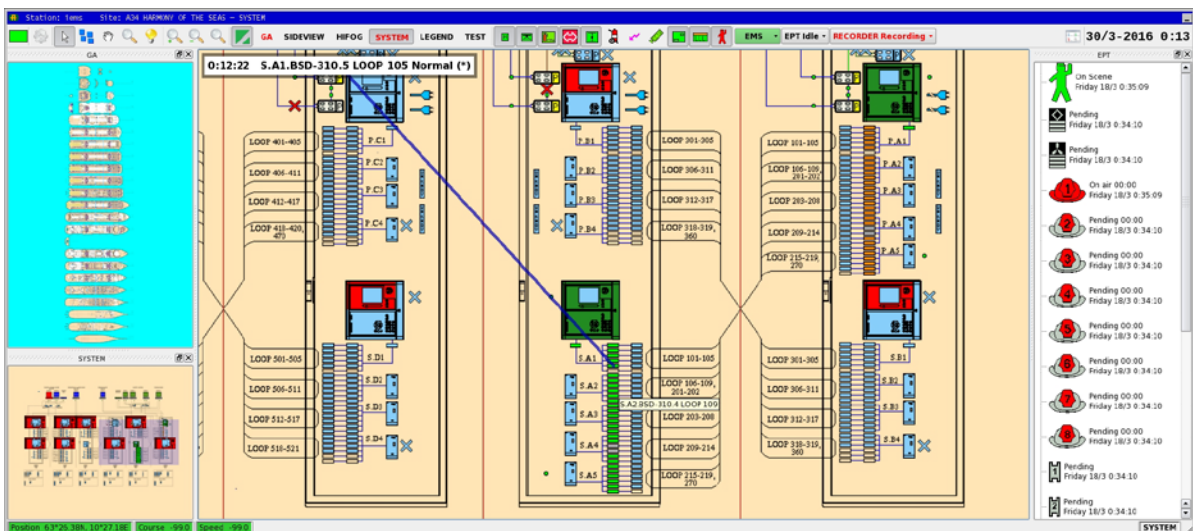

24.5 Automatic Transfer of Loop Control

If loop control is automatically transferred from, for example, the Primary to the Secondary System (or vice versa), all loops are taken over by the Secondary system and the Secondary System enters the Active mode.

The change of loop control can be indicated by colours (configurable).

24.6 Give or Take Loop Control

The command “Give Control” and “Take Control” are used to manually “Give Control” to the other system (either the Primary System or Secondary System), or “Take Control” from the other system (either the Primary System or Secondary System).

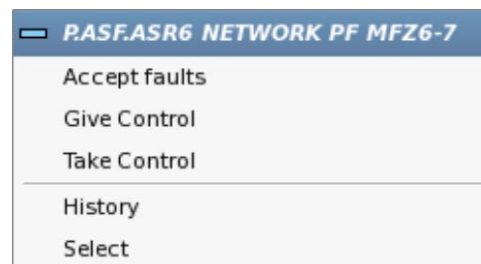
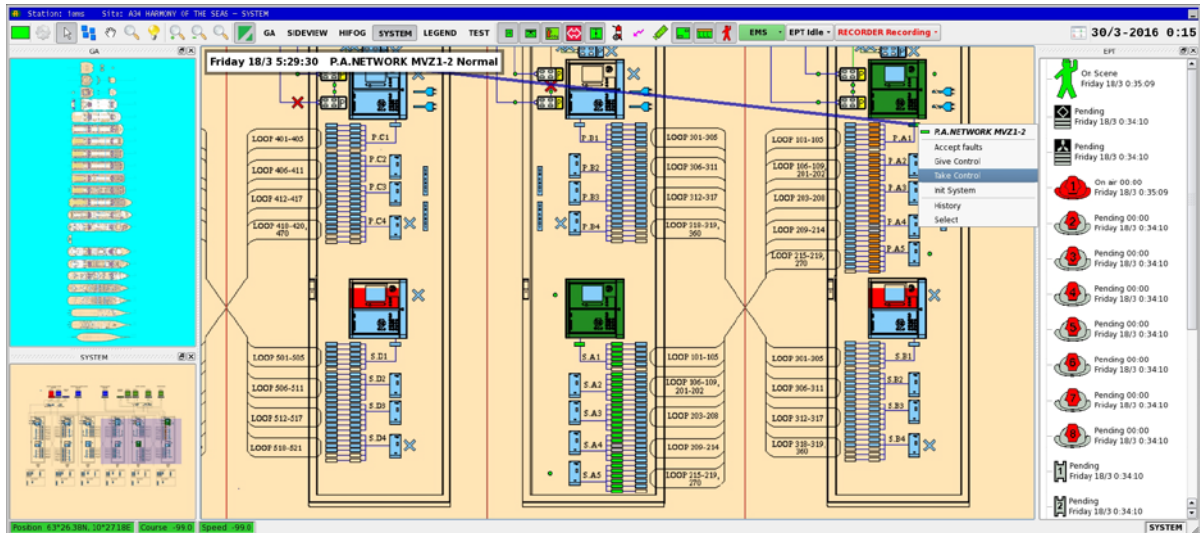

In this way, the Dual Safety functionality (transfer of loop control) can be tested. Furthermore, if for example, it is necessary to do maintenance on the Primary System, the loop control can be temporarily transferred to the Secondary System (or vice versa).

- To manually transfer control from the Primary System to the Secondary System, right-click the Primary System and click Give Control.
- To manually transfer control from the Secondary System and back to the Primary System, right-click the Primary System and click Take Control (or right-click the Primary System and click Give Control).

In the similar way, the loop control can be transferred from the Secondary System to the Primary System, and back to the Secondary System.

25. Duty Control

25.1 Transfer Duty Control

Duty-control transfer is executed on the machine that has duty control.

Duty control may be transferred to the operator of the machine that does not have duty control by clicking On duty with the left mouse button. Before transfer can take place, the would-be recipient must confirm that they is prepared to accept duty control. If the operator confirms their acceptance, then duty control is transferred. If the operator does not accept duty control, duty control remains with the original operator.

Transferring duty control between machine 1 and machine 2.

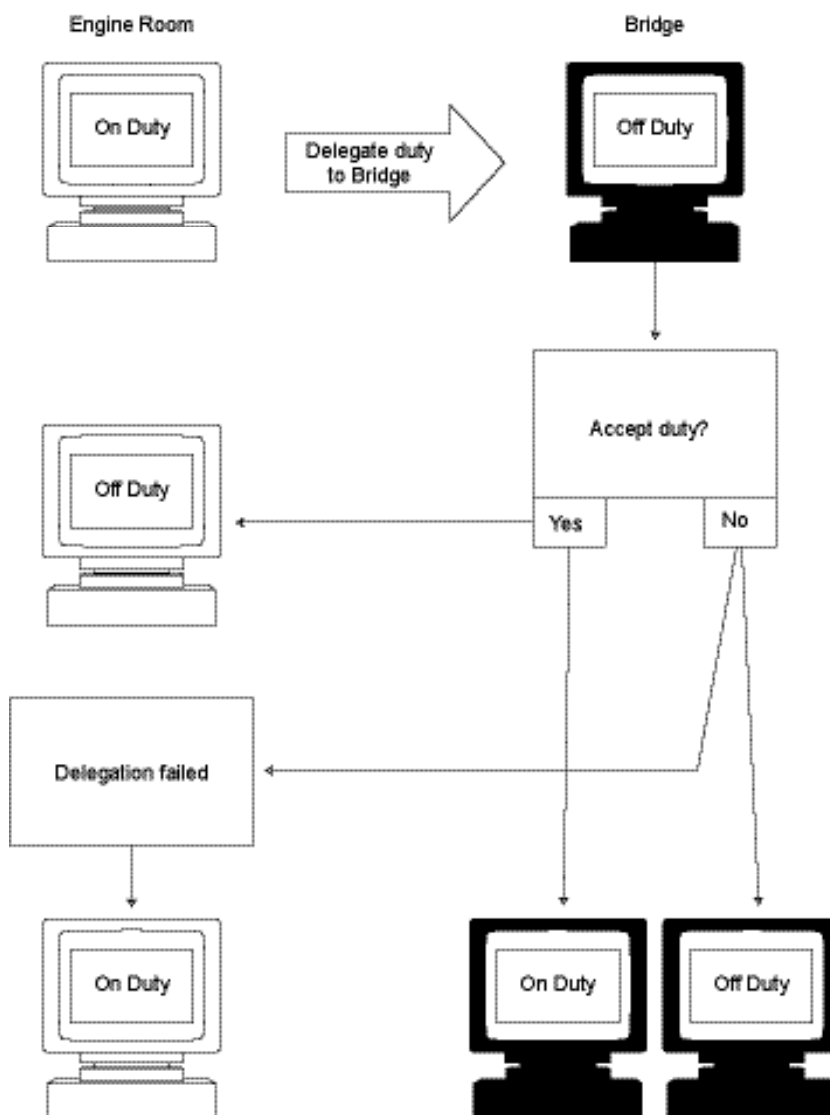

25.2 Acquire Duty Control

Acquisition of duty control is performed by the operator on the machine that does not have duty control.

The operator acquires duty control from the remote machine by clicking Off duty with the left mouse button; duty control will be transferred automatically. On the remote machine, On duty will change to Off duty and an alarm will be sounded until the operator moves the mouse.

Transferring duty control between 2 machines.

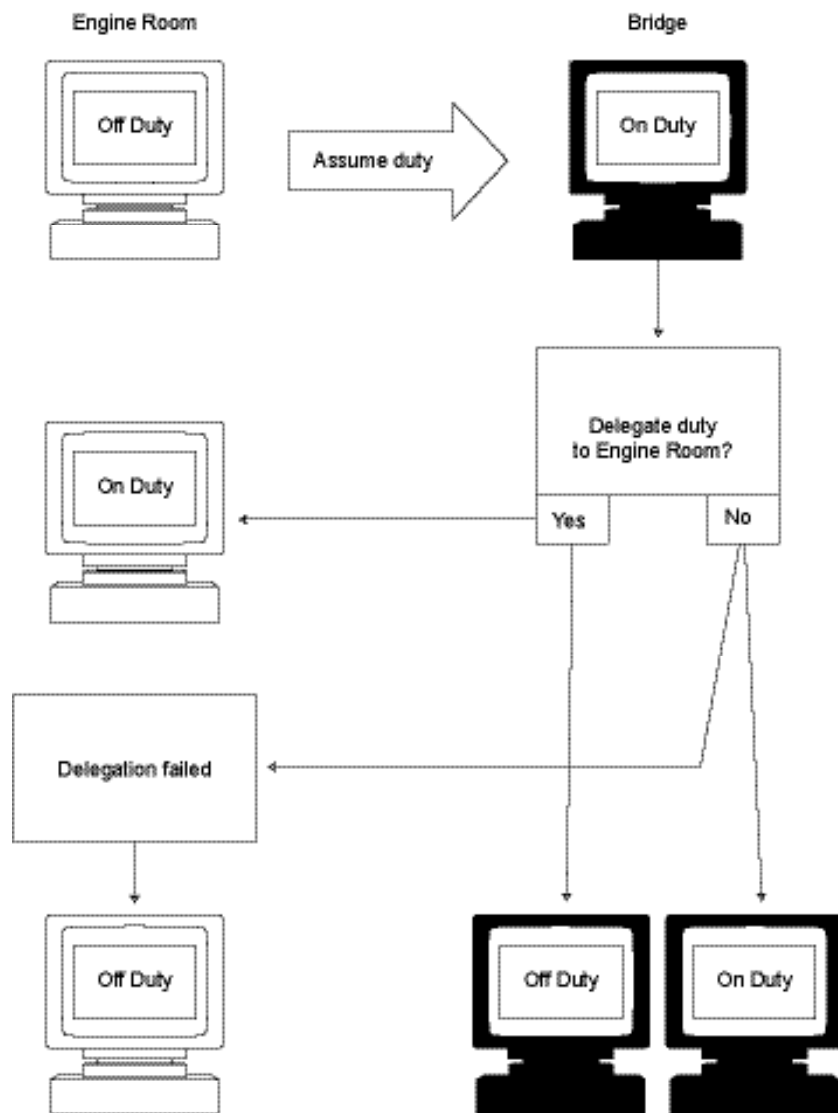

26. Decision Support System

AutoMaster DSS plug-in for AutoMaster provides a decision support system for Cruise vessels. Plug-in architecture means that AutoMaster DSS can be used with new, as well as existing systems.

The incident manager gives operators access to customer-specified checklists. The checklists are organized as checkpoints with one or more action items that can be used to manage operations, and these can be marked off as actions are completed. When an incident is closed, the integrated report generator will generate a report of how the incident was resolved.

26.1 Operating AutoMaster DSS

When the incident manager is started, it opens with no incidents defined as shown below in figure 1.

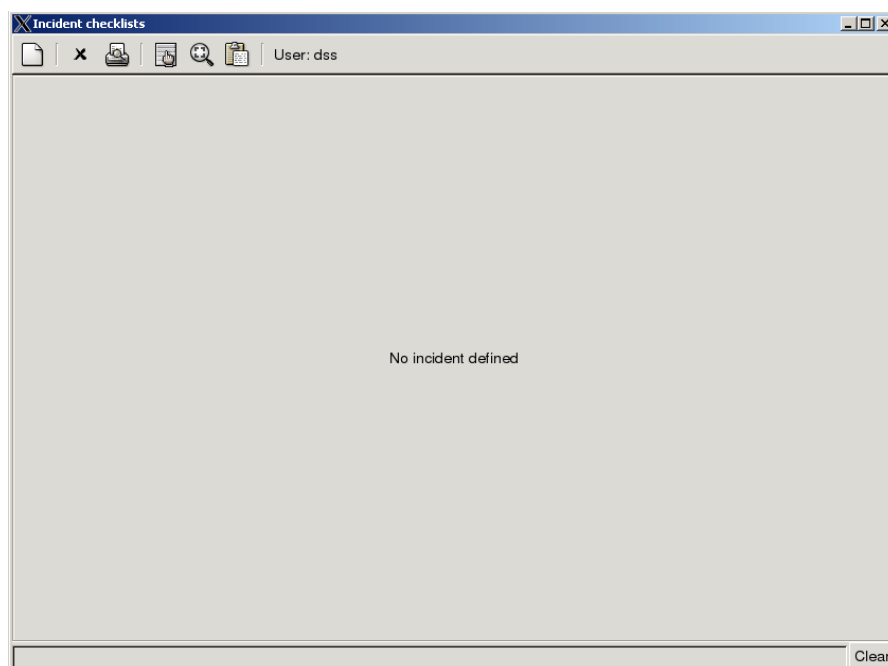

Figure 1 – Incident manager blank page

The top block provides menu selections. This allows the operator to access various functions for overall control of the incident manager. The following functions are available:

- Create new incident
- Close the selected incident and create a report
- Print preliminary incident report for selected incident
- Display normal checklists
- Display incident data fields
- Display log
- User field

The user field shows the user code for the currently defined operator. By pressing the user field, one can change the code. The resulting entry field is shown below. The yellow field at the bottom is the error message area. It is described below.

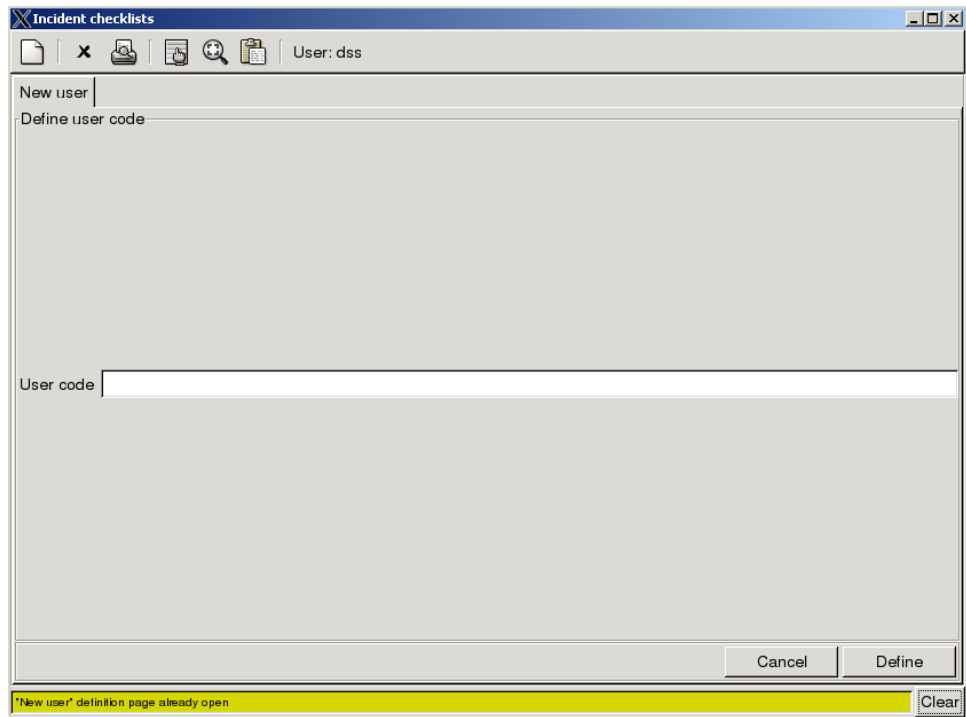

Figure 2 – User entry and error fields

The middle area is where incident information is shown when incidents are active. This is initially empty. Note that the user identification entry function uses this field to enter the new code as shown in figure 2.

The bottom block is the error message area where any error messages are displayed. Pressing the clear button can clear the message area.

26.1.1 Selecting an Incident

An incident is activated by pressing the leftmost New Incident button in the menu bar. A new definition page will appear as shown in figure 3.

Figure 3 – Define incident

From this page, the operator can fill in the generic data fields and the jump directly into an incident by pressing one of the icons in the top-level menu bar. Alternatively, the operator can select a specific incident from the pull-down menu and get an updated picture with all data fields related to a specific incident.

Field names with an “X” in the right margin are read only names, and cannot be changed. Those with a small button at the right hand side can be updated from data which is automatically collected by the manager. Each press of the button updates the data field. It is also possible to select whether the incident is a drill or not.

When data is being entered, the border around the field turns black to indicate a change. The change takes effect as soon as this border is removed, by pressing TAB or by moving the cursor to another field.

When the define button is pressed, all entered data is stored and associated with the incident. The data can be changed afterwards by pressing the Close Incident or “Display Incident Data Field” button (number four in the menu bar).

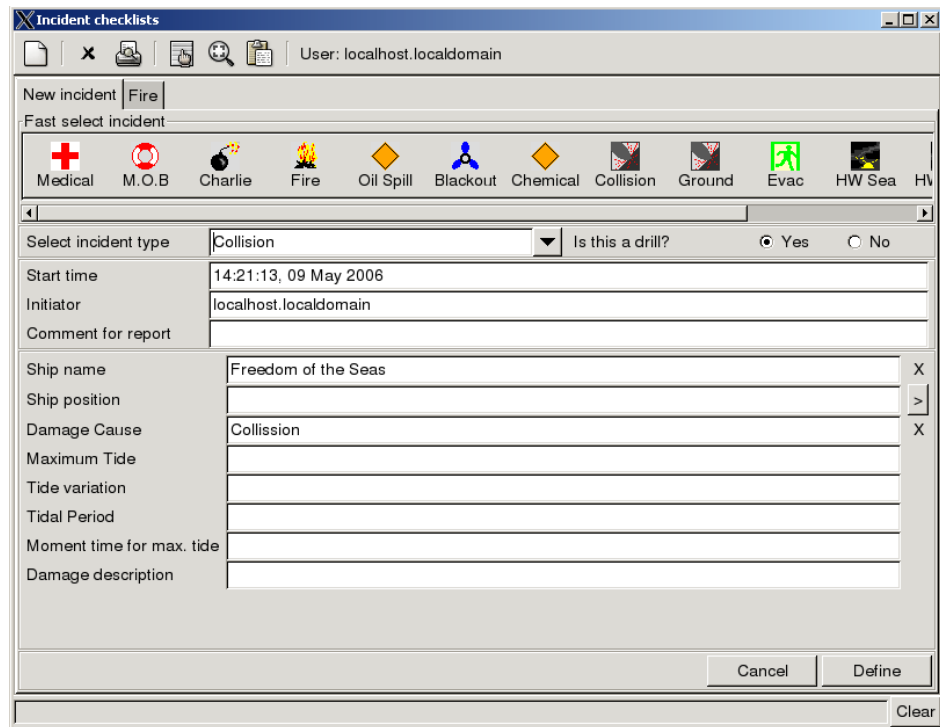

Figure 4 – Extended field incident definition

26.1.2 General Layout of the Incident Viewer

Figure 5 shows the incident manager when an incident is active.

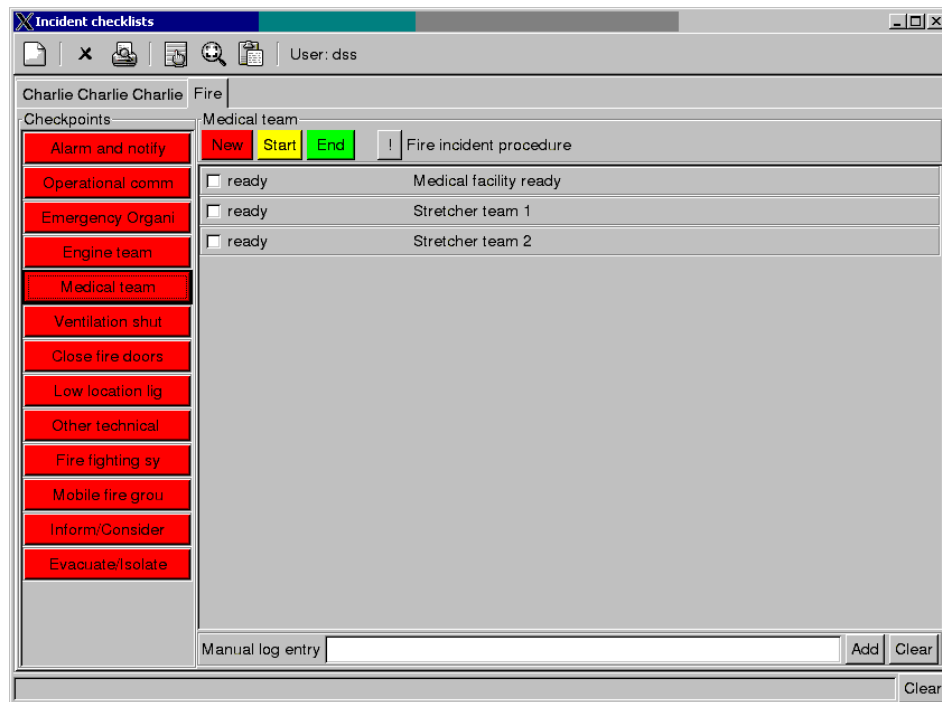

Figure 5 – Overview of incident manager

The first block below the menu bar is a set of tabs, one for each active incident. Selecting one of the tabs changes the content of the rest of the application area for the selected incident. Tabs will also exist for new incident definition or user code definitions, if these are active.

Below the tab area, to the left, is the checklist area. This area consists of a number of coloured buttons. These indicate the status of the respective checklist item. The button is used to call up the action list for each checklist item. The checklist button representing the selected action list is highlighted with a black border.

To the right and at the top is the checkpoint control area. One of the coloured buttons can be pressed to change the state of the checkpoint, regardless of action states. The buttons to the right of these, if available, are used to bring up additional information on the management of this incident. In this case a "Fire incident procedure" can be called up for additional information on handling the incident. These buttons may also generate reports, for example, of fire screen doors that failed to close.

Below the control area is the action area. This area consists of a number of actions that are supposed to be undertaken as part of the checklist item. The operator has various options for signalling progress on the action item, depending on the type. The easiest is a tick off box.

Finally, at the lower end of the incident page is the log entry area. This area gives the possibility to add a manual entry to the log.

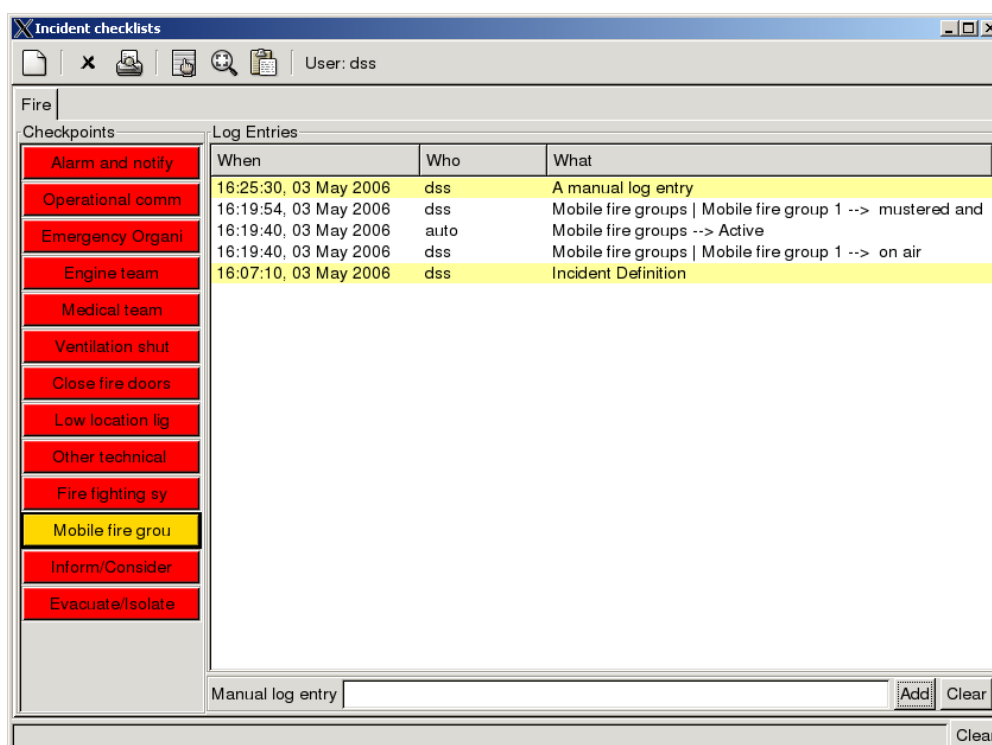

Figure 6 – Log window

26.1.3 Log Entry View

The log entry window is a part of the incident display that can be activated by the log display button in the menu bar (rightmost button). The log entry display takes the place of the action area, but leaves other elements of the incident view unchanged.

The log is currently organized from newest on top to oldest at the bottom. Each entry consists of the time stamp (when), the activation identity (who) and the actual entry. Most entries will be related to actions and checkpoint status changes. However, also manual entries are listed. The initial incident definition and any manual log entries are highlighted to make it easier to identify them.

The codes “auto” in the Who field are used for changes that were a consequence of other actions, i.e., a main checkpoint change state as a result of an action. The code “am5000” is used for actions that were taken based on automatic input from the fire management system.

26.1.4 Data Field View

The data field view for an incident shows the same data elements that are displayed during incident definition. The view is created by replacing the action area with the data area. It is activated by pressing the “Display Incident Data Fields” button in the menu bar (second to the right).

Data can be changed or updated in the same manner as during incident definition.

Incident checklists

User: dss

Evacuation | Fire

Checkpoints

- Lifejackets
- Evacuate ship
- Mustering boats
- Mustering rafts
- Ready boats
- Signal
- Equipment
- Launch boats
- Launch rafts
- AB Bridge

Incident data fields

Is this a drill? Yes No

Start time: 16:30:28, 03 May 2006

Initiator: dss

Comment for report:

Ship name: Freedom of the Seas

Ship position: At sea

Really quit? No: Go back Yes: Close

Manual log entry: Add Clear

Clear

Figure 7 – Close view

26.1.5 Incident Close View

The incident is closed by pressing the close button (second to the left, the "X") in the menu bar. It is similar to the data field view, except that a confirmation button is displayed at the bottom of the data area.

The operator can cancel the close operation by pressing "Go back", or confirm by pressing "Close". The closing will pop up the report generator and allow the user to save the report if desired.

Before closing the incident, the operator can also change any of the data fields to make them appear in the final report.

26.1.6 Reports

To print a preliminary incident report for a selected incident, click the printer icon.



The Report Generator will appear. For further information, refer to Report Generator, chapter 9.

26.1.7 Operator Action Data Entry

As noted above, the operator will have different ways to change action items in the action area. This section lists the main possibilities.

26.1.7.1 No Actions

Some checkpoints have no actions associated with them. In this case the action area just contains a text string with the same content as the text associated with the checkpoint.

26.1.7.2 No Status Change

Some action items may not allow status changes. In this case, there is normally just a label in the action data field.

	Preparation of tools and clean up equipment
<input type="checkbox"/> done	Consider opening of side doors if this action will assist the operation

Figure 8 – No status change

This is illustrated as the upper line in the figure.

26.1.7.3 Single Check Button

Most actions have a single tick-off box. This is checked by clicking the box or the label (illustrated in the second line of Figure 8).

26.1.7.4 Multiple Selections

Some action points have multiple states. This is illustrated in figure 9.

It is indicated by a multiple selection entry. By pressing the down arrow, a selection list pops up. The status can be changed multiple times, for example, to indicate different stages in a process.

pending	▼	Mobile fire group 6
pending	▼	Mobile fire group 8
pending		Backup Mobile fire group 1
mustered and ready		Backup Mobile fire group 2
on scene		
active		BA control Mobile fire group 1
on air		
pending	▼	BA control Mobile fire group 2

Figure 9 – Multiple states

26.1.7.5 Additional Text or Number Entry

An action can also be associated with an additional text entry field. An example is shown below. The field is normally added as a new line under the action line in the action entry. A special case is where there is no status associated with the action. In this case, the data entry field will be the only line in the action entry.

on air	▼	Mobile fire group 1
0:17		Time on air

Figure 10 – Additional data entry

The normal case is when the text field is associated with the action. A timer field indicates a timer which runs when the mobile group has the state “on air”. It is not possible for the operator to change this value other than by setting the state.

The field can be of any type (sum, timer, number or text) and can be associated with any of the action data entry types described above.

26.1.7.6 Additional Information

In some cases an action is associated with a specific instruction or report, accompanied by an information button.

<input type="checkbox"/> done	Alarm signal (7 short/1 long)
<input type="button" value="!"/>	Instructions on alarm signals

Figure 11 – Additional instruction

The functionality of the button is similar to the instruction button in the control area. It will perform a function, typically pop up a kill card or generate a report when pressed.

26.1.7.7 Matrix View

Actions can be organized in a matrix, for example, for keeping track of mustering counts. All types of actions can be used in each cell of the table, but the most common are check boxes or data entry fields.

Figure 12 shows an example of how a matrix view could be constructed. It contains a mix of empty fields, number entry fields, check boxes and pull-down menus. Any combination of these elements can be used.

	Total	Crew	Passenger
Station 1	112	56	56
Station 2	121	56	65
Station 3	110	55	55
Extra rafts 1		<input checked="" type="checkbox"/> done	found ▼
Extra rafts 2		<input type="checkbox"/> done	lost ▼

Figure 12 – Action matrix view

27. Electronic Plotting Table

NOTE:

The display views, buttons, elements, mimics, colours and symbols used throughout this manual are configurable and based on examples. These may therefore not necessarily correspond to the actual ones used for a specific configuration.

27.1 Introduction

The Electronic Plotting Table (EPT) shows the location of important safety features. In addition to showing an overview and the location of fire zones, extinguishing equipment and special areas within the Detail Pane, the Electronic Plotting Table allows you to:

- add, move and remove graphical objects in the mimic to indicate safety incidents
- add, move and remove graphical objects in the mimic to indicate location and status of damage control teams, OOW, fire-fighting teams smoke-divers and other actors
- connect timers to actors/objects plotted in the EPT to monitor time in the mimic, for example, for smoke-divers to monitor time on air
- add, move and remove graphical objects in the mimic to indicate known damage data and location
- add, move and remove graphical objects in the mimic to indicate persons requiring assistance, hazardous materials, etc.
- handle up to three incidents at a time

All EPT activity will be logged using the Decision Support System's Incident Manager.

NOTE:

In order to log EPT activity, the Decision Support System must be started.

27.2 Actors and Objects

27.2.1 Introduction

The symbols are divided into two main groups; Actors and Objects. All available symbols are displayed both in the EPT Actors and Objects Pane and in the upper left hand corner of the Detail Pane.

Note that the type, the number and appearance of symbols are configurable. This chapter gives an example of Actors and Objects typically used on a vessel.

27.2.2 Symbols Displayed in the EPT Actors and Objects Pane

The EPT Actors and Objects Pane displays all available Actors and Objects.

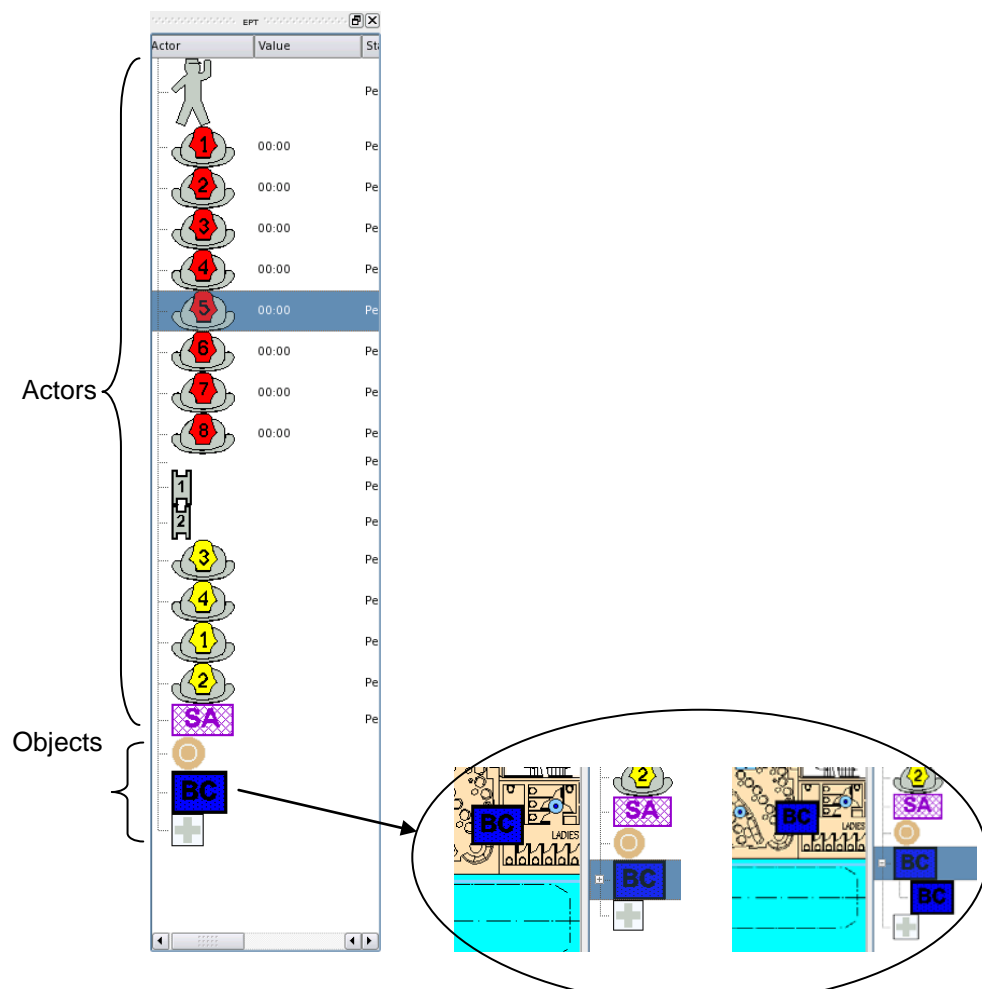

Objects: In this example, the Objects are the 3 lowermost symbols in the pane. Note that, if for example, the symbol "BC" (Boundary Cooling) is selected and placed inside the Detail Pane, the next available symbol ("BC") will appear. To expand one level and reveal all available symbols ("BC"), click (+).

27.2.3 Actors

The Actors are represented by the following symbols (configurable):



On Scene Commander



Mobile Fire Group (numbered)



Stretcher Team (numbered)



Supply Team (numbered)



Staging Area

27.2.4 Objects

The Objects are represented by the following symbols (configurable):



Source Location



Boundary Cooling (BC)



Casualty

27.2.5 Symbol Information

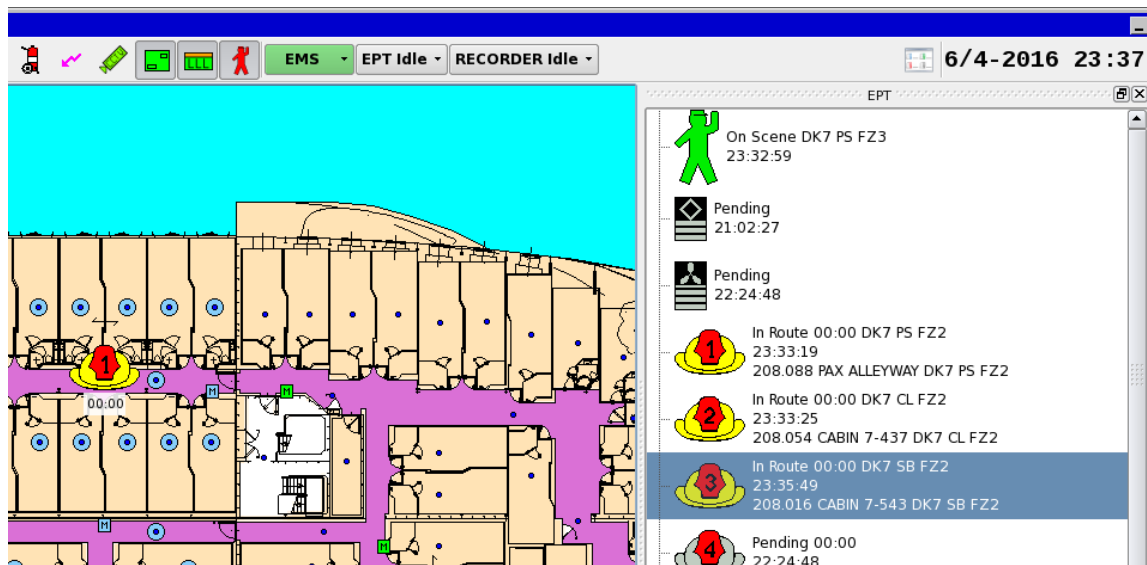

When a symbol is selected in the EPT Actors and Objects Pane, the selected Actor or Object will be highlighted.

- The type of the symbol; Actors or Objects
- Position
The approximate position (deck, fire zone, side, etc.)
- State
For each symbol, there are different states (for example, Initiate, Active, On air, etc.). For detailed information on the various states for each symbol, refer to the next chapter (Symbol State Indication).
- Time
The time the symbol last changed its state
- Position
The exact position of an Actor or Object in the Detail Pane which is based on the position of the nearest loop unit

27.2.6 Symbol State Indication

Depending on the symbol in question, the state of a symbol can be indicated by a specific colour, by its shape or whether it is flashing or not.

In the example below, the three different states for the symbol representing On Scene Commander are shown:

- Pending or Inactive (grey)



- Initiate (yellow)



- Active (red)



For detailed information on , refer to the chapter dealing with each symbol.

27.3 Accessing Symbol Menus

The menu for a symbol can be accessed from the Detail Pane or the EPT Actors and Objects Pane (the On Scene Commander symbol is shown in the two examples below).

27.3.1 Inside the EPT Actors and Objects Pane

- Right-click a symbol inside the EPT Actors and Objects Pane, hold down the right mouse button and scroll downwards to select one of the available menu selections, then left-click the selected menu.

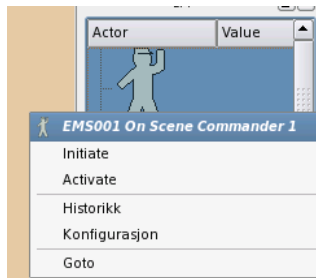

(The Go to menu selection is available only when a symbol is chosen in the EPT Actors and Objects Pane).

27.3.2 Inside the Detail Pane

- Right-click a symbol inside the Detail Pane, hold down the right mouse button and scroll downwards to select one of the available menu selections, then left-click the selected menu.



27.4 Drag and Drop

Symbols can be dragged and dropped anywhere inside the Detail Pane:

- Left-click the symbol.
- While holding down the left mouse button, place the symbol at the desired location, then simply release the mouse button to place the symbol at this location.

Note that, as soon as a pending/inactive symbol is moved, the state of the symbol will change (Initiated, Defined). (This does not apply to Source Location, Boundary Cooling and Casualty).

27.5 Cleaning Symbols

This menu selection allows you to remove all or selected symbols from the Detail Pane (configurable). The screenshot below shows an example of available menu selections for the button configured as EMSEPT Idle.

- Left-click the EMSEPT Idle menu.
- Scroll downwards to select one of the available menu selections (Clean All, Clean Fire Team, etc.), then left-click the selected menu.

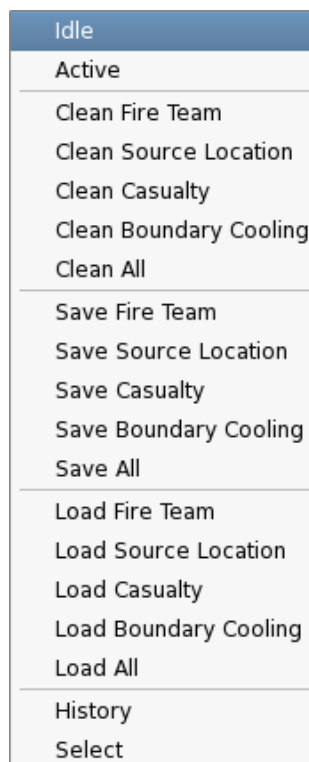

27.6 Polygons

27.6.1 Overview

To more exactly pinpoint the location of a symbol and show the approximate area the symbol covers, a symbol can be resized and shaped if a polygon is added to the symbol.

Example:

- Drag and drop a “Boundary cooling” symbol into the Detail Pane
- Right-click the symbol, then select “Add polygon”

A square box in the same colour as the symbol will surround the symbol in the Detail Pane.

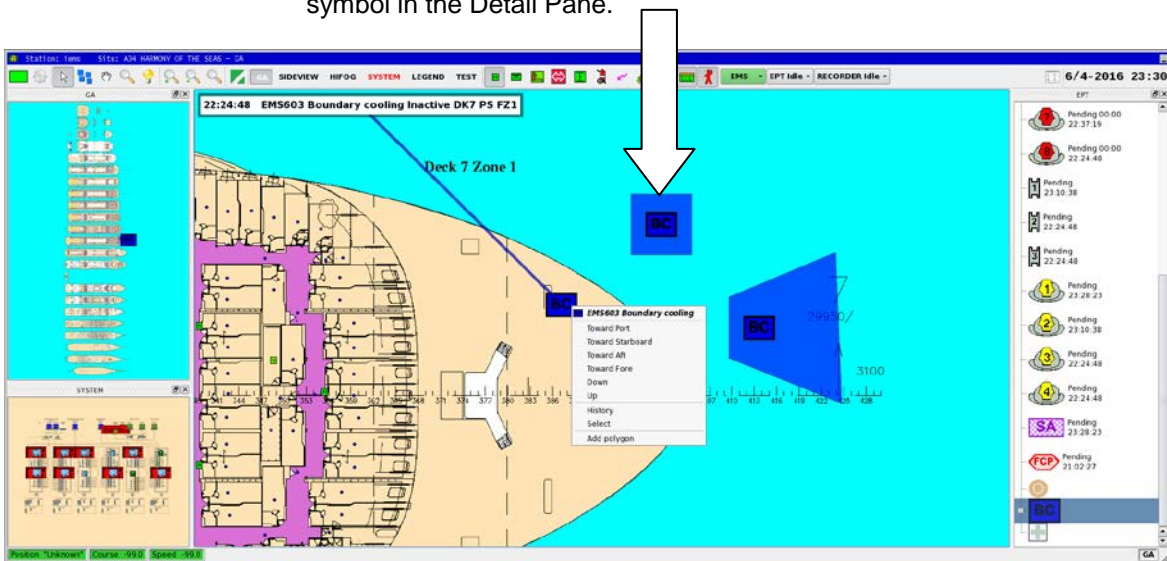

- Move the symbol to the approximate location
- Left-click anywhere on the outline of the box to set an anchor point, then while holding down the mouse button, move the cursor to the desired direction to resize and shape the polygon, then release the button

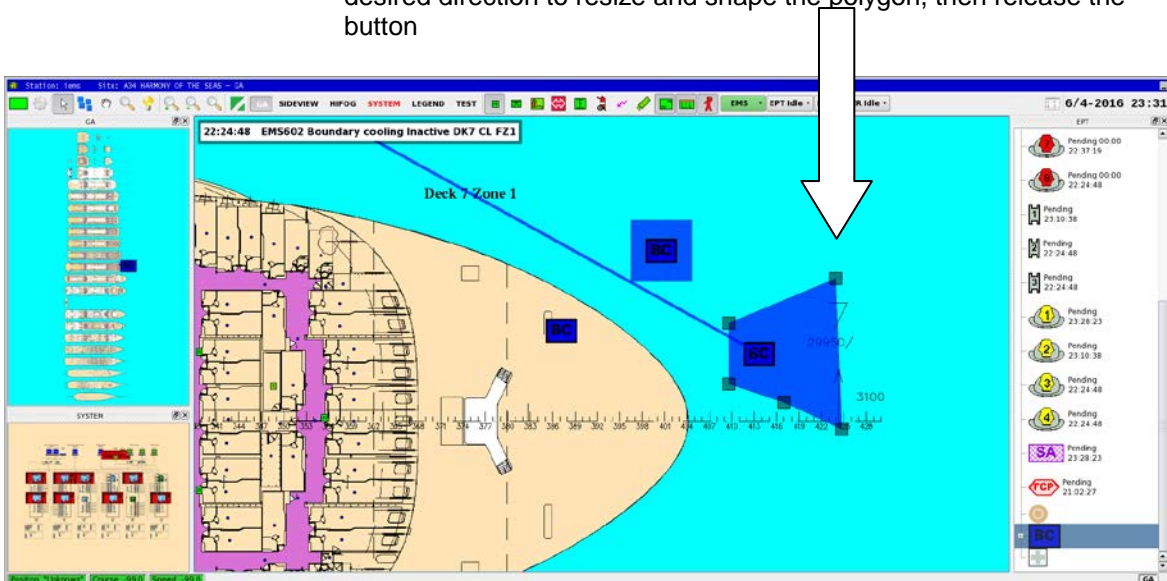

- Left-click to set another anchor point on the outline of the polygon and resize and shape until the polygon has the desired shape

Note: If an existing anchor point is moved right above another anchor point, the anchor point which is moved will disappear when the mouse button is released.

- To remove a polygon from the symbol, select the symbol, right-click and select "Remove Polygon"

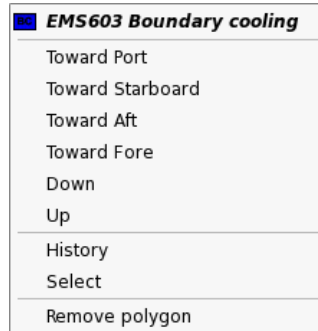

27.7 On Scene Commander Symbol

27.7.1 Overview



The actor symbol On Scene Commander is grey in its pending state.



27.7.2 Menu Selections

- Right-click the symbol, hold down the right mouse button and scroll downwards to select one of the following menu selections.



Menu Selection	Description	Symbol appearance
Initiate	Menu selection used when the On Scene Commander is initiated.	 Yellow
Active	Menu selection used when the On Scene Commander is active.	 Red
History	Provides a history window. See general description, chapter 27.15.	
Configuration	Provides configuration possibilities.	
Goto	Menu selection available only when symbol is selected in the EPT Actors and Objects Pane. All available symbols will appear in the upper left hand corner inside the Detail Pane.	

27.8 Mobile Fire Group Symbol

27.8.1 Overview





The actor symbol Mobile Fire Group is grey in its pending state.

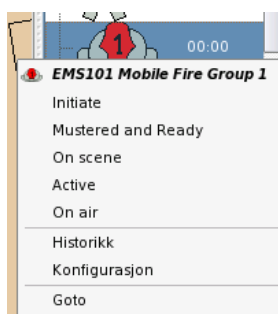

27.8.2 Menu Selections

- Right-click the symbol, hold down the right mouse button and scroll downwards to select one of the following menu selections.



Menu Selection	Description	Symbol appearance
Initiate	Menu selection used when a Mobile Fire Group is initiated.	 Yellow
Mustered and Ready	Menu selection used when a Mobile Fire Group mustered and ready.	 Orange
On scene	Menu selection used when a Mobile Fire Group is on scene.	 Green
Active	Menu selection used when a Mobile Fire Group is active.	 Red
On air	Menu selection used when a Mobile Fire Group is on air.	 Flashing red
History	Provides a history window. See general description, chapter 27.15.	
Configuration	Provides configuration possibilities.	
Goto	Menu selection available only when symbol is selected in the EPT Actors and Objects Pane. All available symbols will appear in the upper left hand corner inside the Detail Pane.	

27.9 Stretcher Team Symbol

27.9.1 Overview



The actor symbol Stretcher Team is grey in its pending state (when it is withdrawn).



27.9.2 Menu Selections

- Right-click the symbol, hold down the right mouse button and scroll downwards to select one of the following menu selections.



Menu Selection	Description	Symbol appearance
Initiate	Menu selection used when the Stretcher Team is initiated.	 Yellow
Standby	Menu selection used when the Stretcher Team is standby.	 Orange
On scene	Menu selection used when a Stretcher Team is on scene.	 Green
History	Provides a history window. See general description, chapter 27.15.	
Configuration	Provides configuration possibilities.	

27.10 Supply Team Symbol

27.10.1 Overview



The actor symbol Supply Team is grey in its pending state.

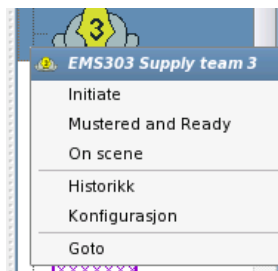

27.10.2 Menu Selections

- Right-click the symbol, hold down the right mouse button and scroll downwards to select one of the following menu selections.



Menu Selection	Description	Symbol appearance
Initiate	Menu selection used when the Supply Team is initiated.	 Yellow
Mustered and Ready	Menu selection used when a Supply Team is mustered and ready.	 Orange
On scene	Menu selection used when a Supply Team is on scene.	 Green
History	Provides a history window. See general description, chapter 27.15.	
Configuration	Provides configuration possibilities.	
Goto	Menu selection available only when symbol is selected in the EPT Actors and Objects Pane. All available symbols will appear in the upper left hand corner inside the Detail Pane.	

27.11 Staging Area Symbol

27.11.1 Overview



The actor symbol Staging Area is purple/transparent in its pending state. When shown in the Detail Pane, the background colour will be seen.

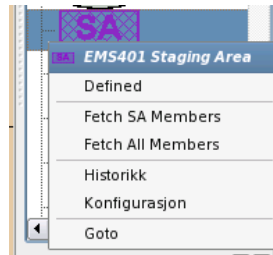

27.11.2 Menu Selections

- Right-click the symbol, hold down the right mouse button and scroll downwards to select one of the following menu selections.



Menu Selection	Description	Symbol appearance
Defined	Menu selection used when the Staging Area is defined.	 Transparent
Fetch SA Members	Menu selection used when all Staging Area members are to be allocated to the Staging Area.	 Transparent
Fetch All Members	Menu selection used when all Staging Area members are to be allocated to the Staging Area.	 Transparent
History	Provides a history window. See general description, chapter 27.15.	
Configuration	Provides configuration possibilities.	
Goto	Menu selection available only when symbol is selected in the EPT Actors and Objects Pane. All available symbols will appear in the upper left hand corner inside the Detail Pane.	

27.12 Source Location Symbol

27.12.1 Overview





The object symbol Source Location is light brown in its pending state.

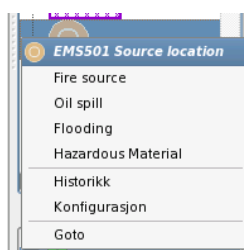

27.12.2 Menu Selections

- Right-click the symbol, hold down the right mouse button and scroll downwards to select one of the following menu selections.



Menu Selection	Description	Symbol appearance
Fire Source	Menu selection used to state the location of a fire source.	 Red with the letter S
Oil Spill	Menu selection used to state the location of oil spill.	 Black with the letter S
Flooding	Menu selection used to state the location of flooding.	 Blue with the letter S
Hazardous Material	Menu selection used to state the location of hazardous material.	 Yellow
History	Provides a history window. See general description, chapter 27.15.	
Configuration	Provides configuration possibilities.	
Goto	Menu selection available only when symbol is selected in the EPT Actors and Objects Pane. All available symbols will appear in the upper left hand corner inside the Detail Pane.	

27.13 Boundary Cooling Symbol

27.13.1 Overview

The object symbol Boundary Cooling is grey in its Inactive state.



27.13.2 Menu Selections

- Right-click the symbol, hold down the right mouse button and scroll downwards to select one of the following menu selections.

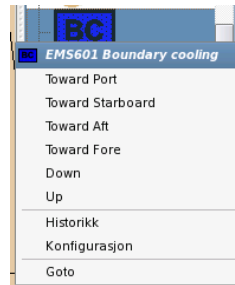

Menu Selection	Description	Symbol appearance
Toward Port	Menu selection used to state the location of boundary cooling toward port.	Blue
Toward Starboard	Menu selection used to state the location of boundary cooling toward starboard.	Blue
Toward Aft	Menu selection used to state the location of boundary cooling toward aft.	Blue
Toward Fore	Menu selection used to state the location of boundary cooling toward fore.	Blue
Down	Menu selection used to state the location of boundary cooling down.	Blue
Up	Menu selection used to state the location of boundary cooling up.	Blue
History	Provides a history window. See general description, chapter 27.15.	
Configuration	Provides configuration possibilities.	
Goto	Menu selection available only when symbol is selected in the EPT Actors and Objects Pane. All available symbols will appear in the upper left hand corner inside the Detail Pane.	

27.14 Casualty Symbol





The object symbol Casualty is grey in its pending state.

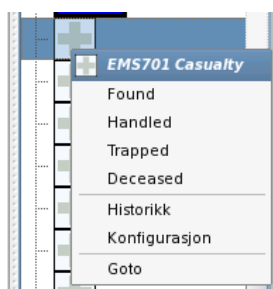

27.14.1 Menu Selections

- Right-click the symbol, hold down the right mouse button and scroll downwards to select one of the following menu selections.



Menu Selection	Description	Symbol appearance
Found	Menu selection used to state the location of a casualty.	 Flashing Red
Handled	Menu selection used to state the location of a casualty and that the casualty is taken care of.	 Green
Trapped	Menu selection used to state the location of a casualty and that the casualty is trapped at this location.	 Black
Deceased	Menu selection used when a casualty has deceased.	 Grey inside the Detail Pane. The symbol disappears in the EPT Actors and Objects Pane.
History	Provides a history window. See general description, chapter 27.15.	
Configuration	Provides configuration possibilities.	
Goto	Menu selection available only when symbol is selected in the EPT Actors and Objects Pane. All available symbols will appear in the upper left hand corner inside the Detail Pane.	

27.15 History Window

A history window is available for each symbol.

- Left-click the symbol in question, then click and hold down the right mouse button, and scroll downwards to select and left-click the History menu.

The following will appear on the screen (example):

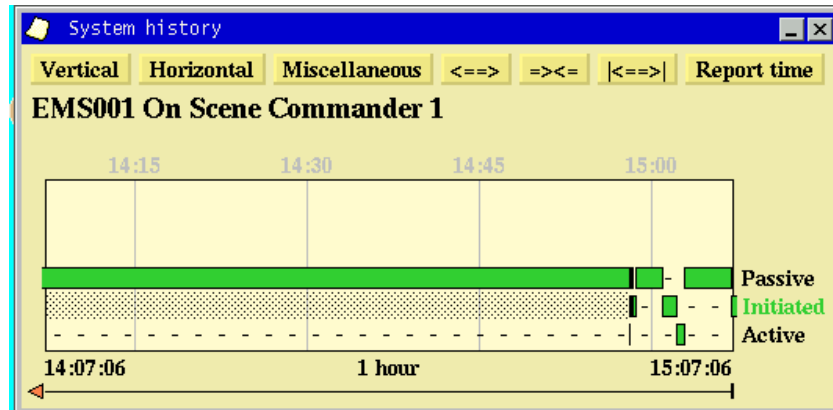

For detailed information on the History Window, refer to standard Operator's Handbook (116-P-AM5000/FE), chapter 13.

28. Event Recording and Replay

28.1 Introduction

The Event Recording and Replay Module offers a screenshot-based replay of incidents on AutoMaster.

The module can be configured to automatically start recordings on pre-configured events, or manually by means of the Event Recorder button.

Recordings are available for replay, and during replay the operator can start, stop, pause, or replay fast forward and fast backward.

It is also possible to export stored events to a USB memory stick.

The module replays only incidents that have occurred on the computer it is running on. Stored events are available from the Report Generator.

28.2 Automatic Start of Recordings

The Event Recording and Replay module can be configured to start recording on pre-configured events as prewarnings, alarms or simulation. The recording lasts until it is manually stopped (reset), or automatically after a predefined period after the incident is off.

28.3 Manual Start and Stop of Recordings

- To start a recording manually, click the Start Recording button (in this example the button is named ER001 Idle).
- To stop the recording, click the Stop Recording button.



28.4 General Layout

The general layout of the module consists of a sequence window to the left, the replay window to the right, and status information and function buttons at the bottom.

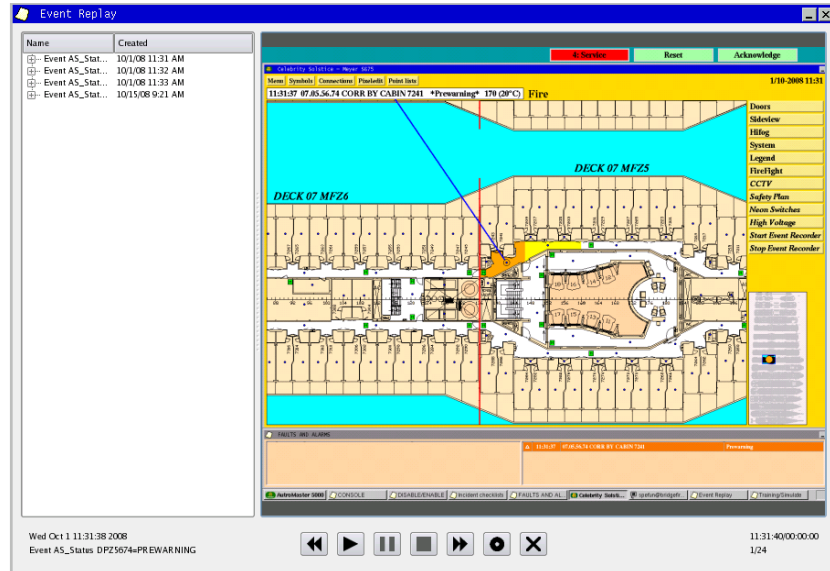

28.4.1 Toggling between Full Scale Picture and Zoom

- To toggle between full scale picture and zoom, simply place the cursor inside the picture area and left-click the mouse.

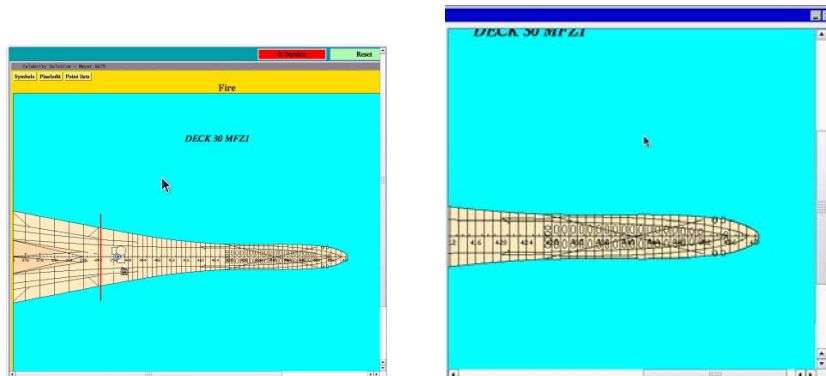

28.4.2 Sequence Window

The sequence window shows the name of the sequences as well as the date and time they occurred.

name	created
Event grabber-control-start manual	9/25/08 12:30 PM
Event grabber-control-start manual	9/25/08 1:56 PM
Event grabber-control-start manual	9/25/08 2:24 PM

name	created
Event grabber-...	9/25/08 12:30 PM
1	9/25/08 12:30 PM
2	9/25/08 12:30 PM
3	9/25/08 12:30 PM
4	9/25/08 12:30 PM
5	9/25/08 12:30 PM
6	9/25/08 12:31 PM
7	9/25/08 12:31 PM
Event grabber-...	9/25/08 1:56 PM
8	9/25/08 1:56 PM

28.4.3 Information in Bottom Window



Example:

Wed Oct 1 11:31:38 2008
(states the date and time of the recording)

Event AS_Status DPZ5674=PREWARNING
(states the name of the function/button)

Example:

11:31:40/00:00:00
(states the exact time of when the sequence occurred)

1/24
(means sequence 1 of a total of 24 recorded sequences)

28.4.4 Function Buttons

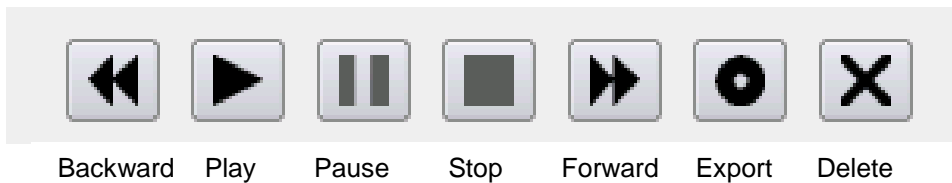

Note that the function of each button appears when moving the cursor right above the button. The tool tip for the Export button is shown in the example below.

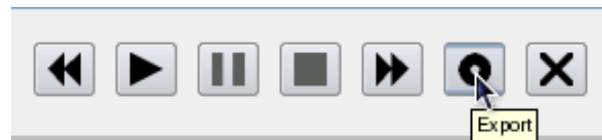

28.4.5 Play Button

28.4.5.1 Replaying a Sequence

- To replay a sequence, from the sequence window, select the one you want to replay, then click the Play button.

The sequence is replayed in a default speed (x1). The replay speed can be changed (faster or slower) during replay (see next chapter).

Note that during the replay of a chosen sequence it is not possible to choose another sequence (if any). The sequence that is replayed must be stopped before another one can be selected and replayed.

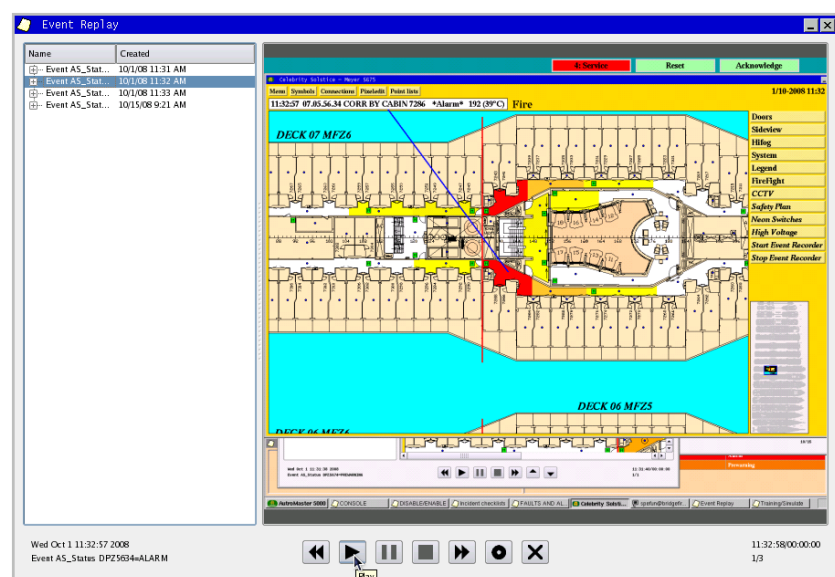

28.4.5.2 Changing the Replay Speed

The replay speed can be changed during replay. The default speed is indicated with "x1" at the bottom right hand corner.

The fastest replay speed is 64 times the default speed (x64). The slowest is half the default speed x32 (-).

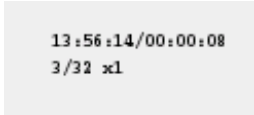

13:56:14/00:00:08
3/32 x1

- To speed up the replay, click the Forward button 

Clicking the Forward button once gives twice the speed (x2), clicking it twice gives four times the speed (4x), clicking it three times gives eight times the speed, and so on.

- To halve the speed of the replay, click the Backward button 

Clicking the Backward button once gives half the speed (x1 (-)), clicking it twice gives a fourth of the speed (4x), and so on.

28.4.5.3 Using the Pause Button during Replay

- To pause the replay of a sequence, click the Pause button 
- To start the replay again, click the Play button.

28.4.5.4 Showing Single Pictures during Replay

During a replay of a sequence, it is possible to browse forward or backward one or several steps to show single pictures.

- Click the Pause button  to pause the replay of a sequence.
- Click the Forward button to show the next single picture in the sequence, or click the Backward button to show the previous single picture.

28.4.6 Export Button

It is possible to export a sequence (shown in the sequence window).

- To export a sequence, from the sequence window, select the one you want to export.

name	created
Event grabber-control-start manual	9/25/08 12:30 PM
Event grabber-control-start manual	9/25/08 1:56 PM
Event grabber-control-start manual	9/25/08 2:24 PM

- Click the Export button.



- From the popup window that appears, choose the directory where you want to save the sequence.

Note that the export function does not work if an event is being replayed.

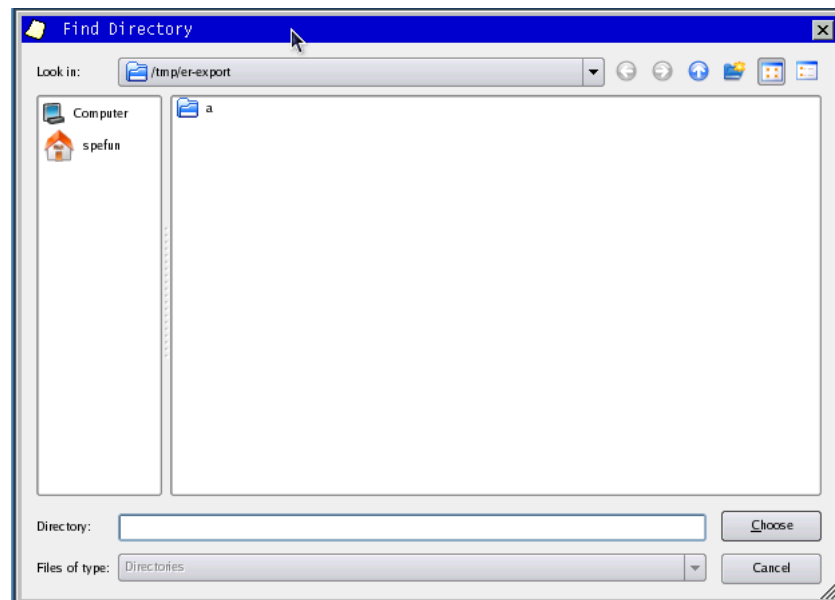

The html file provides a table including a link to each single picture in the chosen sequence.

Event grabber-control-start manual

index	date	time	image
1	2008-09-25	12:30:37	seqimg-2-1.png
2	2008-09-25	12:30:41	seqimg-2-2.png
3	2008-09-25	12:30:46	seqimg-2-3.png
4	2008-09-25	12:30:51	seqimg-2-4.png
5	2008-09-25	12:30:56	seqimg-2-5.png
6	2008-09-25	12:31:01	seqimg-2-6.png
7	2008-09-25	12:31:06	seqimg-2-7.png

28.4.7 Delete Button

Sequences can be deleted from the sequence window.

- To delete a sequence, select the one you want to delete.

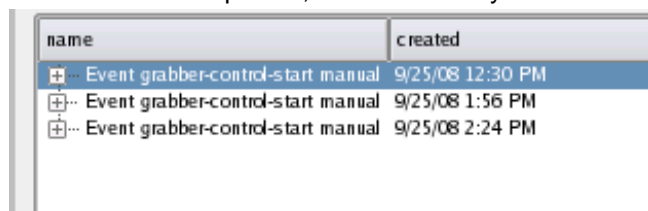

- Click the Delete button.



- If you are sure that you want to delete the sequence, click OK.

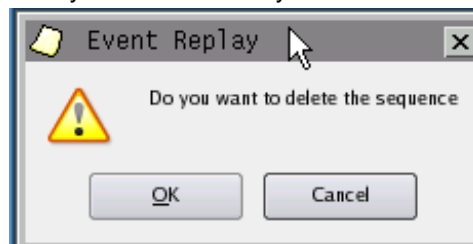

29. Training/Simulate Module

29.1 Introduction

The Training/Simulate Module is a tool used for interactive training and simulation.

With a graphical tool accessible from the menu, an operator is able to simulate (manual or randomly selected) pre-configured scenarios that could take place on the AutoMaster.

During simulation, the operator can observe incidents on the screen, and manage them as if they were real incidents, including:

- acknowledge
- reset
- disable/enable a unit
- operate soft mimic
- Electronic Plotting Table
- Decision Support System

AutoMaster will react correspondingly, presenting the results of the operations by the operator without affecting the system.

During a simulation the operator can pause, stop and continue the simulation. All events will be logged, and when the simulation ends (finished or manually stopped), a full log is generated.

The training module can be integrated with the Event Replay Module to provide replay of the simulation.

29.2 The Training/Simulate Window

The Training module contains the available scenarios used for training purposes.

The following columns are shown:

- Name: the name of the scenario, the location where it takes place
- Delay:
- Type:
- Sub type:
- Value:

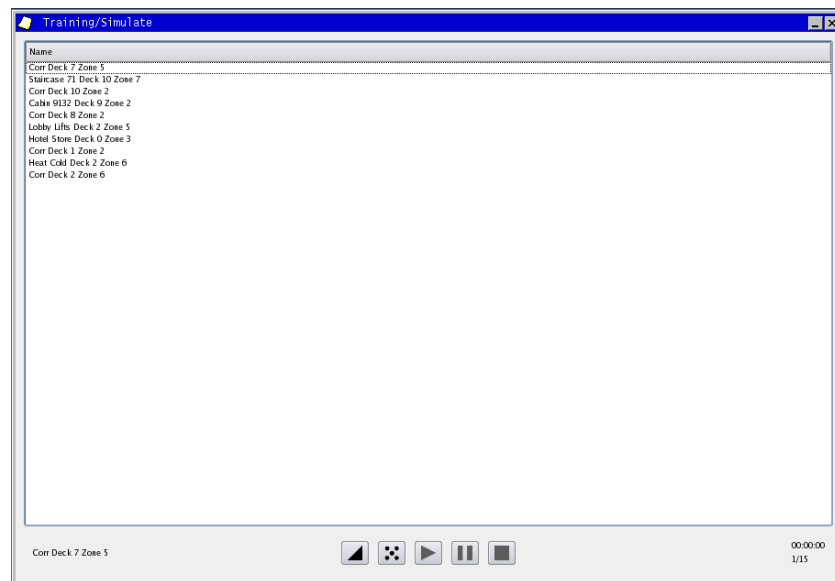

29.3 Function Buttons

The following function buttons are available in the Training/Simulate window:

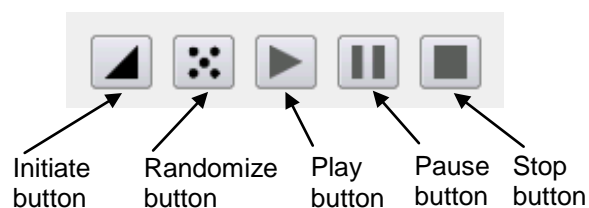

Note that in order to play a chosen scenario (using the Play button), you must click the Initiate button first to initialize the simulation.

A scenario can be chosen randomly using the Randomize button.

During a simulation the operator can pause, stop and continue the simulation.



29.4 Starting the Training Module

- To access the Training Module, click the start menu (configurable).



- Select Maintenance/Service.

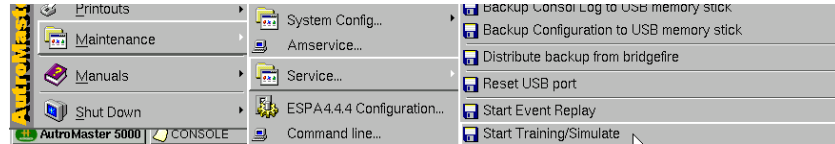

- Select "Start Training/Simulate".

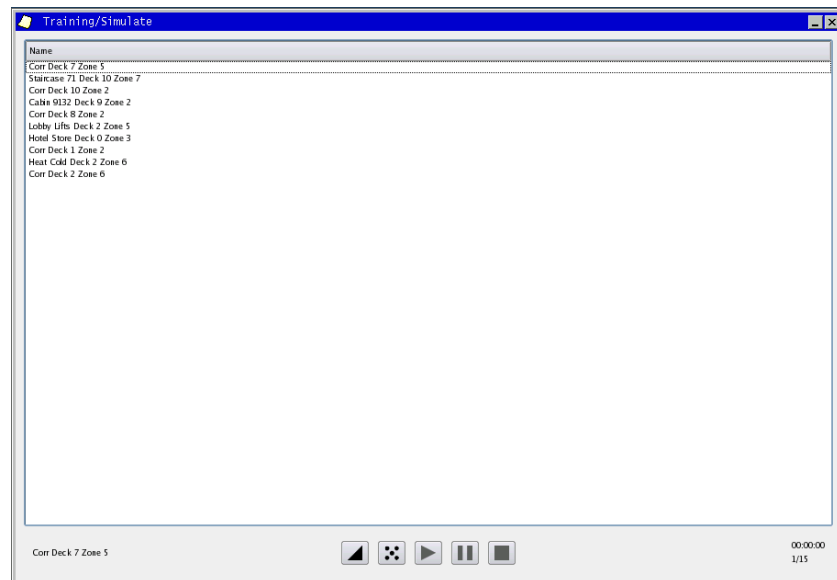

The Training/Simulate window will appear, listing the available scenarios.

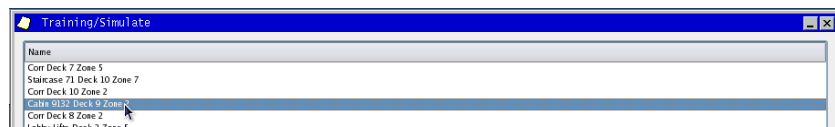

29.5 Starting and Stopping a Scenario

- In the Training/Simulate window, click the desired scenario, or click the Randomize button to select a scenario at random.



- To initiate the scenario, click the Initiate button 
- To play the scenario, click the Play button 
- To stop the scenario when the training session is completed, click the Stop button 



The system automatically starts a recording when an event occurs.

29.6 Starting an Event from the Detail Pane

Instead of starting a scenario for training purposes, you can start an event from the Detail Pane. For example, you can set several detectors in test mode.

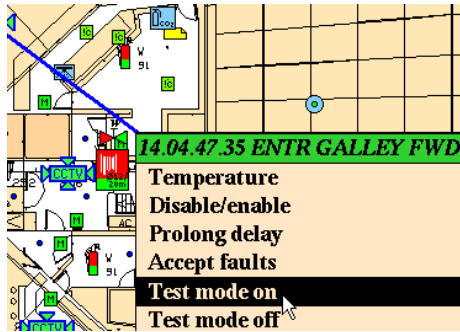
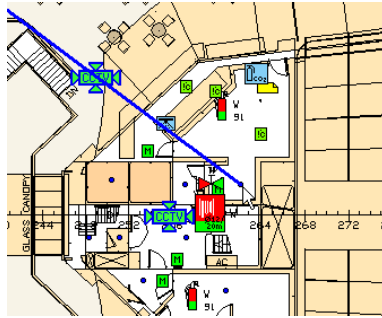
- Right-click a detector, hold down the mouse button, scroll downwards to select Test mode on, then release the mouse button.



- Set other detectors in test mode as described.
- To leave test mode when the training session is completed, click the Initialize button 
- To stop the recording, click the Reset button 

30. Message Center

30.1 Introduction

The Message Center module provide the following:

- Audio messages
- Text messages
- Contacts
- Calendar / Tasks

30.2 Using the Message Center

- Open the Message Center

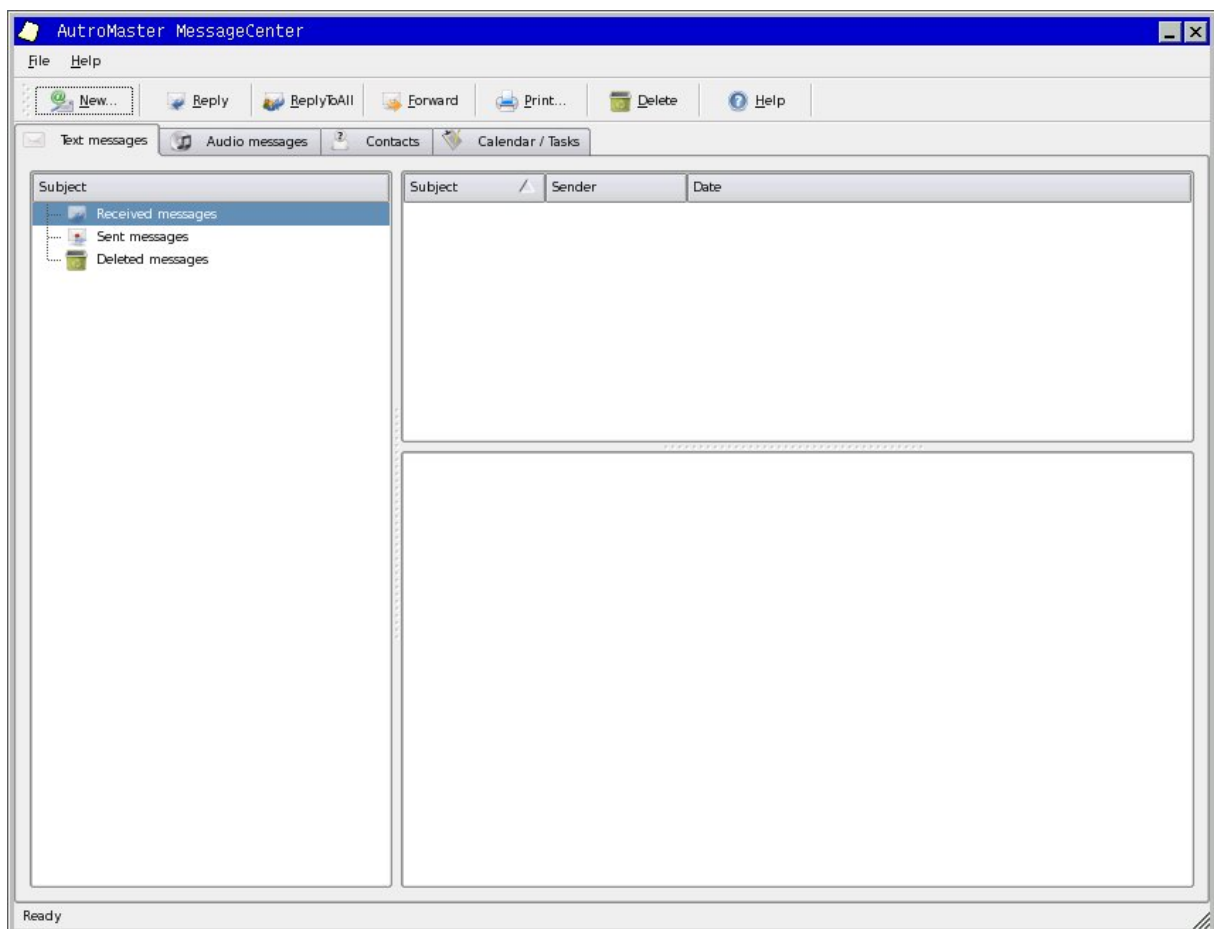

- Click the "Audio messages" tab to open the page where the button can be added.
- Click "Add audio button" in the toolbar

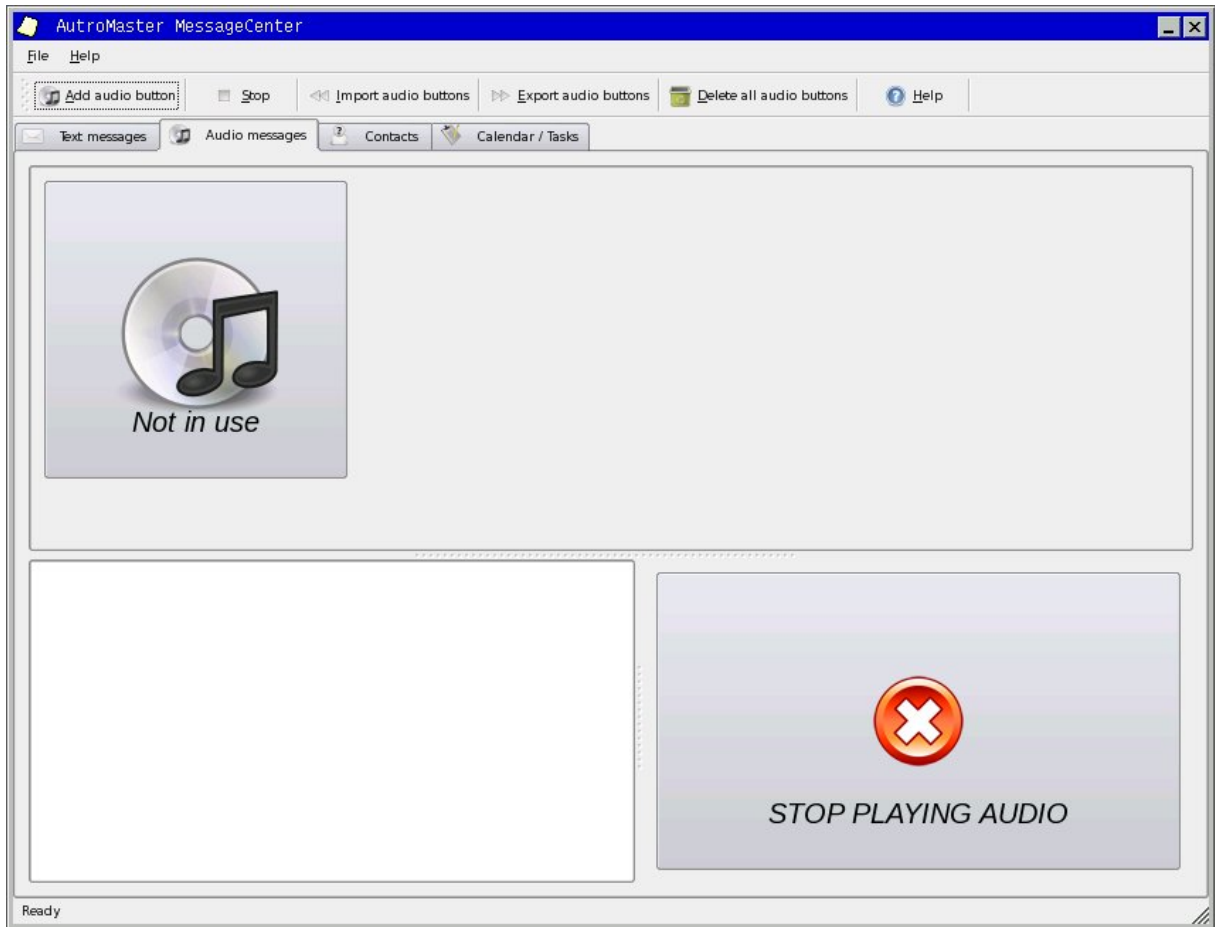

- Right-click the audio button and select "Configure audio button". The following dialogue box will appear:

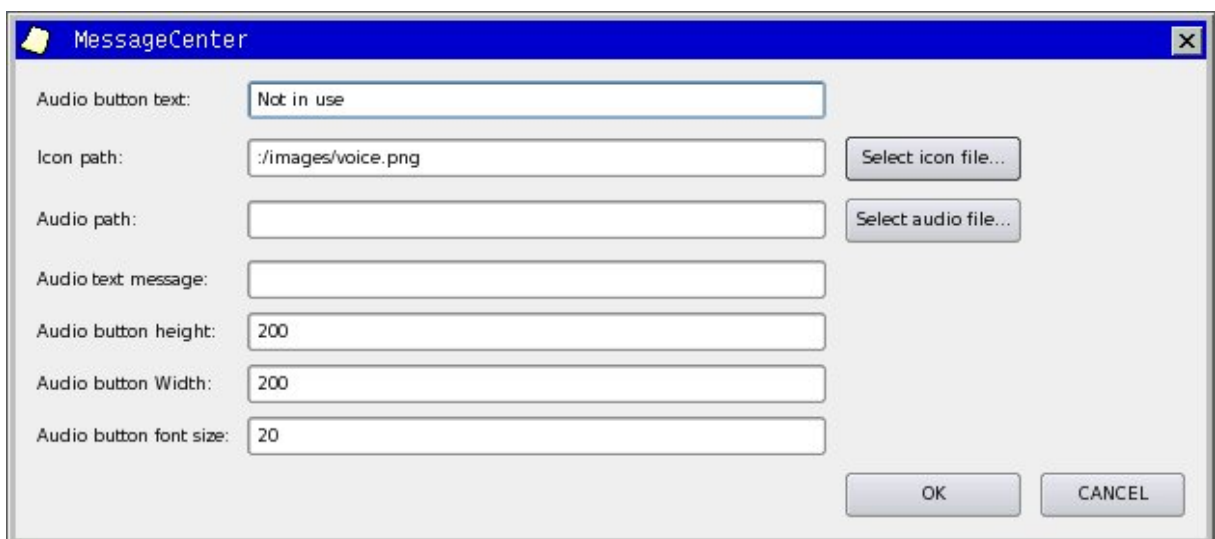

In this dialogue box, you are able to write the text visible on the button, select an icon for the button, state where you have the audio file and state the size of the button as well as the font size. The "Audio text message" will be used for sending commands to the rest of the AutoMaster software (to start/stop activation of PLC for output/input into PA system).

- Click "Select audio file" to open the audio file you want to have for the selected button.

The audio file must be in .ogg format (we are adding possibility to convert from mp3 and other formats to the free .ogg format ASAP). If you need to convert the audio files you have, we recommend using the VLC Media Player available at www.videolan.org. This program has a Convert/Save option in the File menu, and you can convert from almost any format to any other format. MP3 is a copyrighted file format and any software able to play this audio format must pay royalties and make legal arrangements with the copyright holder.

- If you want to open files on USB stick connected to the computer, click the "Computer" icon, then "/" and "mnt" and finally "usb".

If you have problem finding the attached USB memory stick, open a command line window after inserting the USB memory stick and write "mount /mnt/usb" – this should make the USB stick a part of the Linux file system.

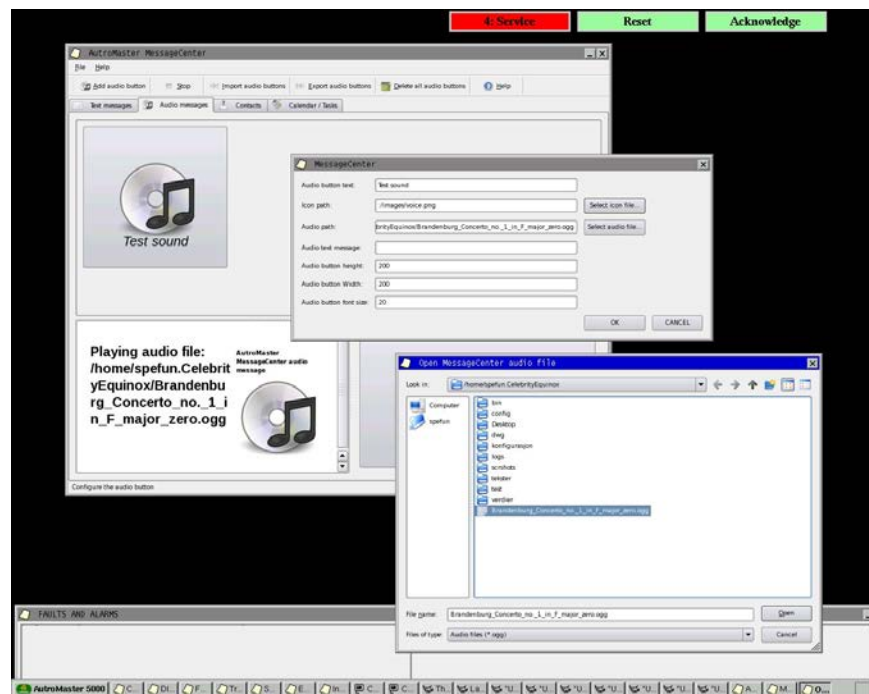

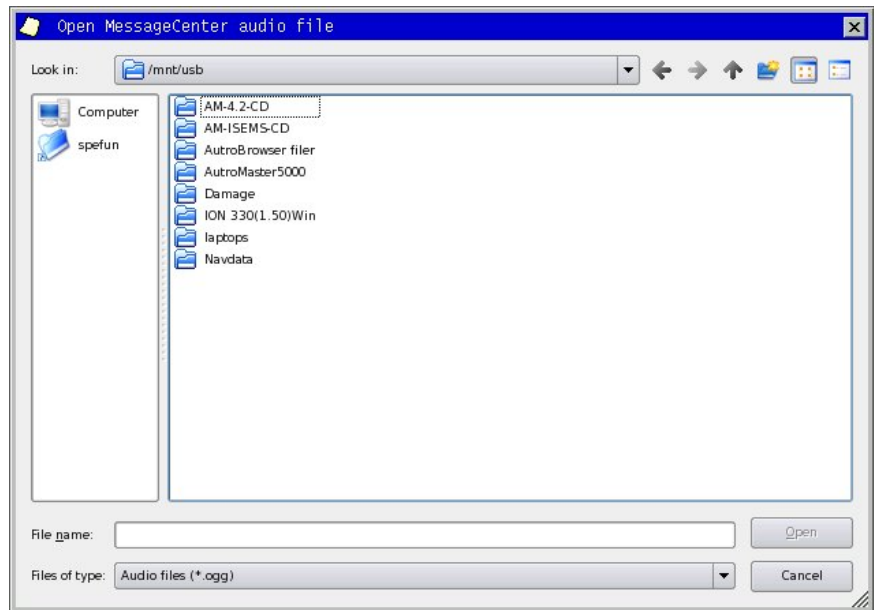

After you have selected the audio file and entered a suitable text for the button, you can press "OK" and the button will be ready to use.

- Click the button and you should be hearing sound from the loudspeakers.

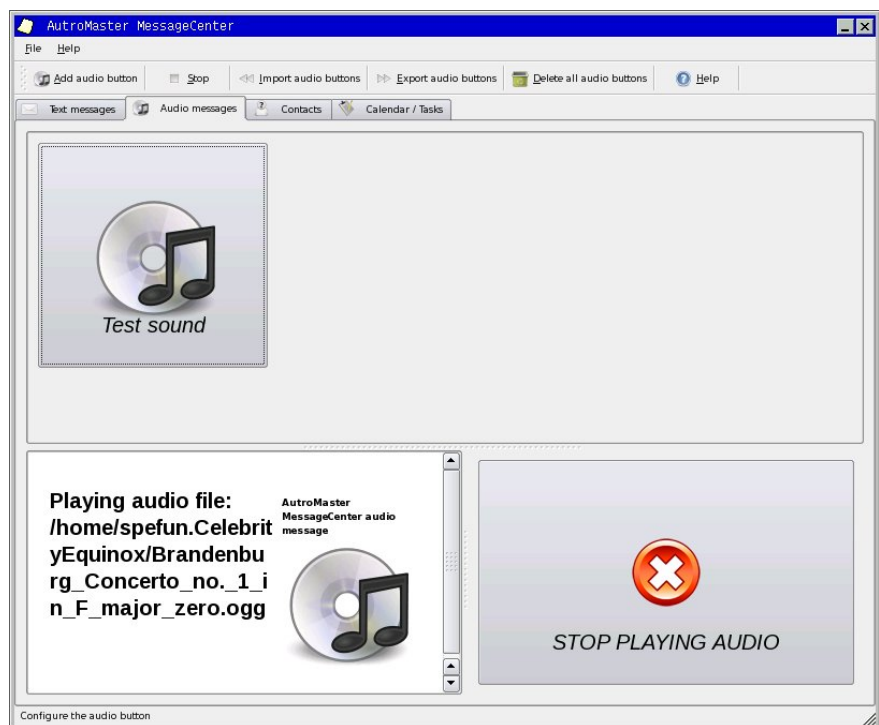

Autronica is a leading innovator, manufacturer and supplier of fire safety equipment. Our products ensure safety in applications on land and sea worldwide. The company is owned by United Technologies Corporation (UTC) and employs more than 380 people with great skill and experience in the developing, manufacturing and marketing of fire safety equipment. Autronica Fire and Security AS is an international company based in Trondheim, a dynamic city known as the technological hotspot of Norway.

Protecting life, environment and property

Autronica Fire and Security AS

Haakon VIIS gt. 4, NO-7041 Trondheim, Norway | Tel: +47 90 90 55 00 | Fax: +47 73 58 25 01

E-mail: info@autronicafire.no | www.autronicafire.com